

---

# Computational Mechanics Tools

## Course Simulation Project - Elasticity

---

Submitted By : <sup>1</sup>Kiran Kolhe, <sup>2</sup>Prakhar Rastogi

Submitted To : Prof. Amir Abdollahi  
Prof. Natividad Pastor

17<sup>th</sup> January 2020

# Contents

---

✚ Details .....	1
✚ Task 1 - Static Analysis of Elastomeric Mat .....	2
• Analytical Stiffness.....	2
• Numerical Stiffness .....	3
• Discussion on Tie constraint and surface to surface interaction. .	5
✚ Task 2 – Static Analysis of the proposed designs of Elastomeric Mat	6
• Design A .....	6
• Design B .....	8
• Comparison between the stiffness.....	10
✚ Task 3 - Dynamic Response analysis of the 3 designs .....	11
• Design 00 ( <u>Initial Design</u> ).....	11
• Design A .....	12
• Design B .....	13
• Comparison Table.....	14
✚ Displacement vs Time plots for the 3 design cases.....	15
✚ Task 4 – Conclusion and Modifications.....	16
✚ Appendix .....	18

## Details

This Simulation Project has been performed on Abaqus CAE Student Edition. Here, an elastic mat used in railway tracks to minimize the vibration caused by train passage, has been analysed for its stiffness. The stiffness is defined as the stress applied divided by the resulting displacement (units  $\text{kN}/\text{mm}^3$ ). These mats are subjected to both the static load (dead weight of the track) and dynamic load from the train passage. The material properties such as density, Young Modulus and Poisson's ratio & dimensions of mat and plate are given.

Given data:

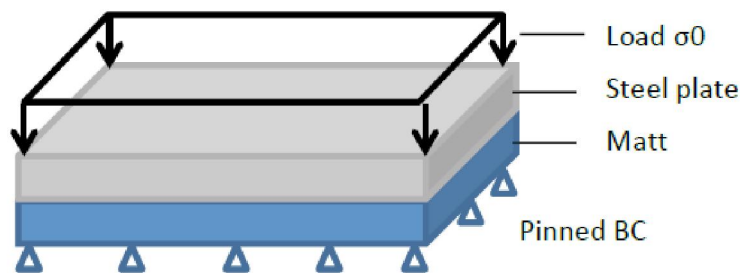

Dimensions of Elastomeric and Plate = 300 mm x 300 mm x 25 mm

Material properties:

Plate:  $E = 210 \text{ GPa}$ ,  $\nu = 0.3$ ,  $\rho = 7800 \text{ kg}/\text{m}^3$

Mat:  $E = 1.3 \text{ GPa}$ ,  $\nu = 0$ ,  $\rho = 800 \text{ kg}/\text{m}^3$

Total Load:  $\sigma(t) = \sigma_0 + \sigma_d \gamma \sin(\omega t) = \sigma_0 + \sigma_d \gamma \sin(2\pi ft)$ .

$\sigma_0 = 2 \text{ N}/\text{cm}^2$ ,  $\sigma_d = 1 \text{ N}/\text{cm}^2$ ,  $\gamma = 1.4$ ,  $f = 5 \text{ Hz}$

The following tasks need to be done:

**Task 1:** Perform the static analysis of the basic simple design of the elastomeric mat. Consider the given data and imply only static load. Compare analytical stiffness and numerical stiffness of the elastomeric mat. Comment on using surface to surface interaction and tie constraint in the analysis.

**Task 2:** Find the stiffness of two more proposed designs by performing computational analysis such that the volume of elastomeric mat remains the same as in initial case. Comment on the results of the design.

**Task 3:** Analyse the dynamic response of these designs. Consider the dynamic load and also plot the displacement vs time graphs for the designs.

**Task 4:** Conclusion and comments on new modification.

## Task 1 – Static Analysis of Elastomeric Mat (initial design-Design00)

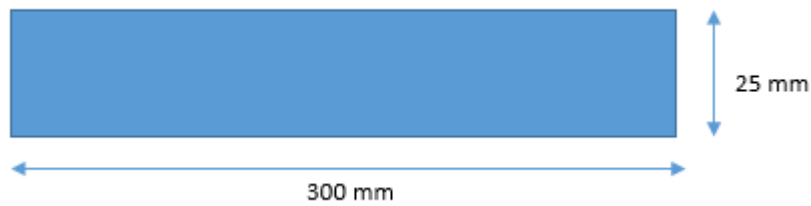

In this case, an elastic mat of 300 mm x 300 mm x 25 mm is being analysed. This mat has a loaded plate over it, and it given a pinned boundary condition at the bottom end. The load acting on the plate is a static load of 20000 N/m<sup>2</sup> initially. The dimensions of the plate and mat are same. Material properties for the mat and plate are taken from the given data. Due to load, the elastomeric mat is deformed and some stresses will be induced. Using the given data, we will calculate the analytical stiffness of the mat. Then, we will compare the obtained analytical stiffness value with the numerical value obtained from computational simulations.

- Analytical Stiffness:

The stiffness is calculated analytically by using the formula:  $K = \frac{\text{Load}}{\text{Change in Length}}$

In this case the load is the initial static load which is 20000 N/m<sup>2</sup>.

The change in length is calculated by using the strain relation.

$$\text{Strain} = \frac{\text{Change in Length}}{\text{Original Length}}$$

And finally using the relation for elasticity,  $E = \frac{\text{Stress (Load)}}{\text{Strain}}$  we find the analytical stiffness.

$$K = \frac{\text{Load}}{\frac{\text{Stress (Load)} * \text{Original Length}}{E}}$$

$$K = \frac{20000 * 1.3 * 10^9}{20000 * 0.025} \text{ N/m}^3$$

All the parameters are taken in following converted format for this analytical conversion:

$$\text{Load} = 2 \text{ N/cm}^2 = 20000 \text{ N/m}^2$$

$$\text{Length} = 25 \text{ mm} = 0.025 \text{ m}$$

$$E = 1.3 \text{ GPa} = 1.3 * 10^9 \text{ N/m}^2$$

The analytically obtained stiffness value is:  $K = 0.052 \text{ kN/mm}^3$ .

- Numerical Stiffness:

The numerical stiffness is calculated by using ‘tie constraint’ and ‘surface to surface interaction’.

- ❖ Tie Constraint plots:

Below figures show the contour plot for variation of stress values and variation of displacement for the elastomeric mat by using tie constraint. The maximum value of von Mises stress obtained is  $2.105 \times 10^4$  Pa. The value of displacement obtained from the U plot for tie constraint over the time is  $3.886 \times 10^{-7}$  m. As we are interested in calculating the stiffness of mat, the steel plate, being stiffer than the elastomeric mat, is hidden for both von Mises and displacement plots.

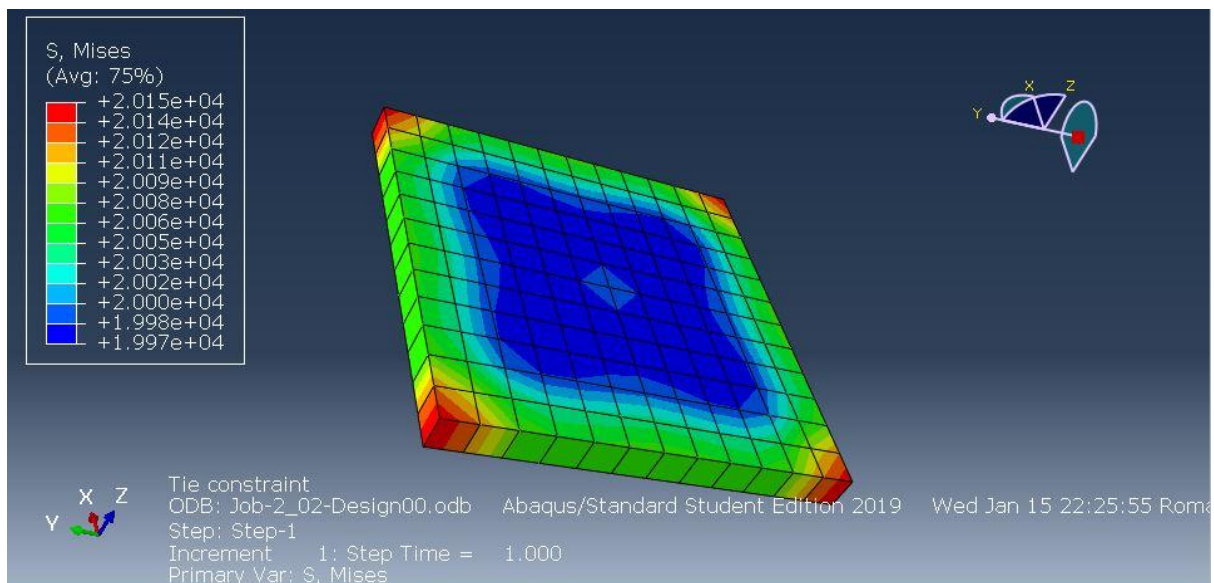

Von Mises stress contour for initial design (design00) with tie constraint

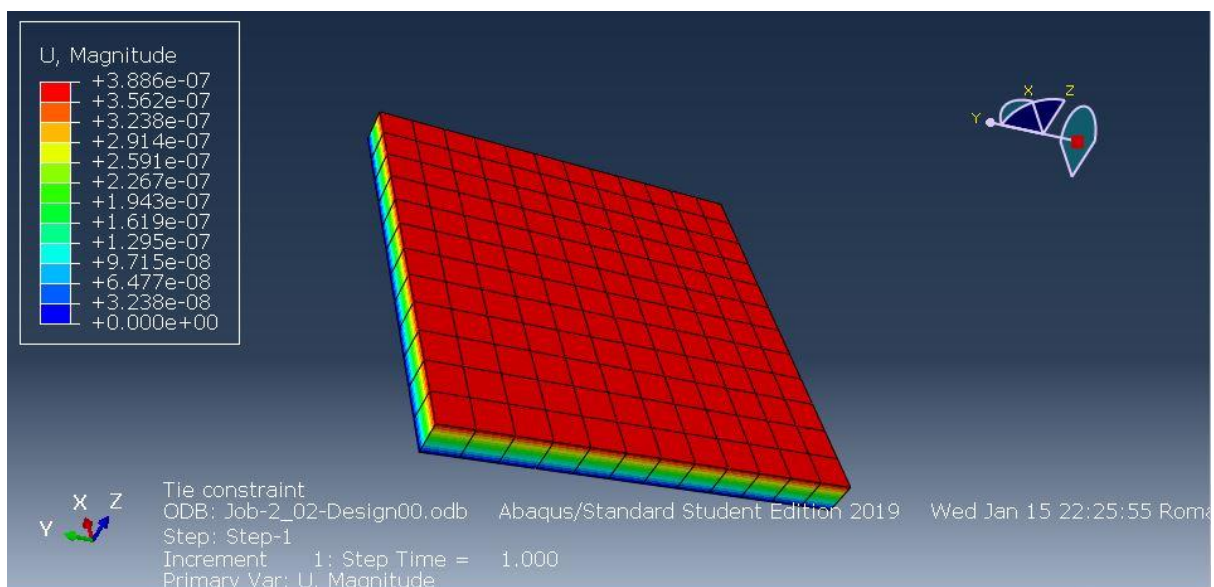

Displacement contour for initial design (design00) with tie constraint

The value of stiffness obtained is  $5.185 \times 10^{10} \text{ N/mm}^3$  or  $0.05185 \text{ KN/mm}^3$ , almost equal to analytical value.

❖ Surface to surface interaction plots:

Below figures show the contour plot for variation of stress values and variation of displacement for the elastomeric mat by using surface to surface interaction. The maximum value of von Mises stress obtained is  $2.000 \times 10^4 \text{ Pa}$  which is seen at the corner of the mat. The value of displacement obtained from the U plot for over the time is  $3.846 \times 10^{-7} \text{ m}$  which is maximum at the top end of the mat.

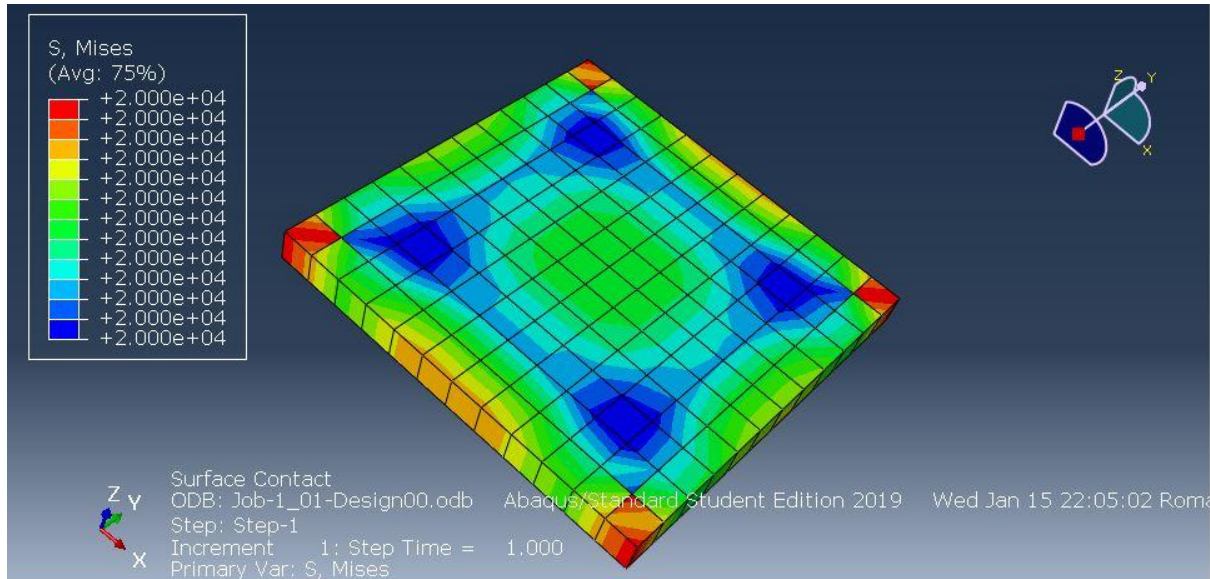

Von Mises stress contour for initial design (design00) with surface interaction

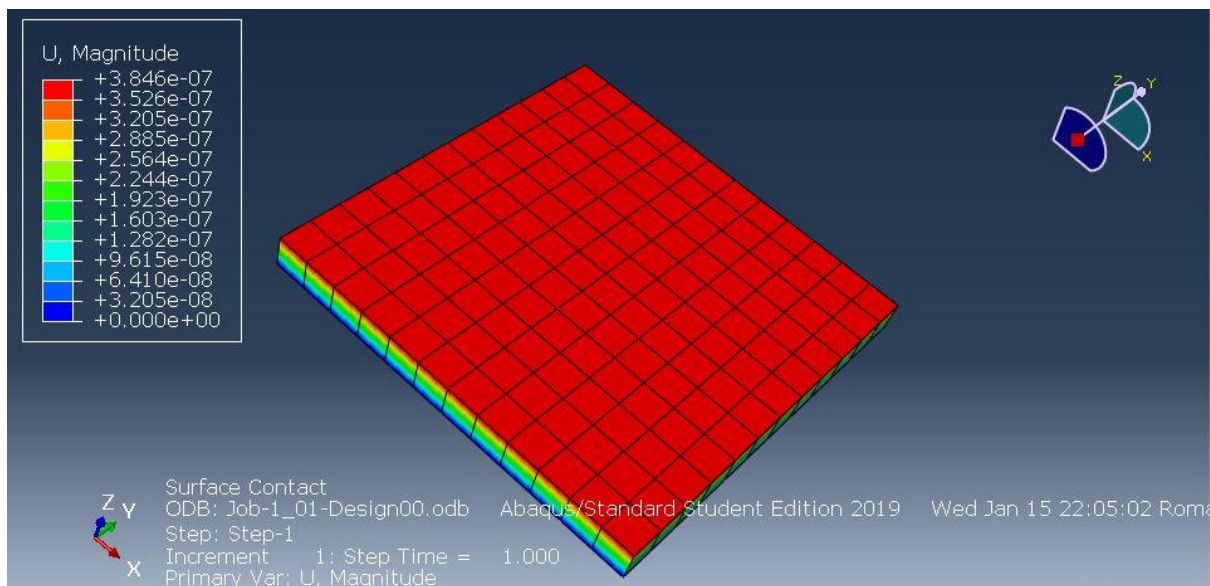

Displacement contour for initial design (design00) with surface interaction

The value of stiffness obtained in this case is  $0.052 \text{ KN/mm}^3$  which matches with the analytical value of stiffness calculated.

- Discussion on Tie constraint and surface to surface interaction:

Tie constraint:

The slave surface can't penetrate into master surface; however, the vice-versa is true. The master surface is the rigid one while slave surface is the elastic one with less rigidity. The direction of contact is always perpendicular to master surface.

By default, the surface-to-surface approach is used in ABAQUS/STANDARD. Unlike the traditional node-to-surface approach, there are no stress oscillations at the interface in the case of mismatched meshes in surface-to-surface approach. The main disadvantage of using this approach over node-to-surface method is the cost factor. If it is not mandatory to take into account local stress accuracy, node-to-surface method can be preferred. As less master surface nodes are associated with every slave surface, the tie is efficient for the size of the fronts of the operator matrix. Further, both degrees of freedom, i.e., rotational and translational, can be tied. The tie constraint restricts the relative motion between the two surfaces.

Surface-to-surface interaction (pressure-overclosure relationship - hard contact model):

The hard contact model of pressure-overclosure relationship reduces the extent of penetration of the slave surface into the master surface at the constraint locations and restricts the transfer of tensile stress across the interface. When two surfaces are in contact, there is pressure transmission between the surfaces. However, when surfaces are separated, no contact pressure is there.

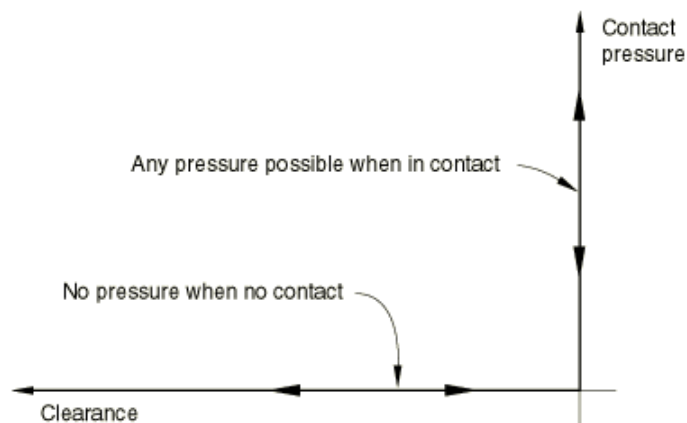

From the results obtained for the above case of Design 00, it is evident that the stiffness for static loading in case of surface-to-surface constraint is more precise than the stiffness value obtained in case of tie-constraint for the above case. So ideally, surface-to-surface hard model relationship should be preferred.

	<b>Tie Constraint</b>	<b>Surface to surface Interaction</b>	<b>Analytical</b>
<b>K</b>	0.05185	0.052	0.052

Stiffness values obtained in  $\text{kN/mm}^3$

## Task 2 - Static Analysis of the proposed designs of Elastomeric Mat

Considering the above comparison that the numerical value of stiffness obtained and the analytical value of stiffness calculated for the basic design of the elastomeric mat were moreover same, we analyse more designs of the mat for its effectivity. The goal is optimizing material efficiency which means, to achieve same stiffness with less material. An important consideration made here is that the volume of the elastomeric mat remains same for all the designs. Also, note that, for experimental purposes the elastomeric mat was sandwiched between 2 steel plates. But for analysis, the lower plate can be ignored by giving pinned boundary conditions on the bottom face of the mat. 2 different designs are analysed here.

- Design A:

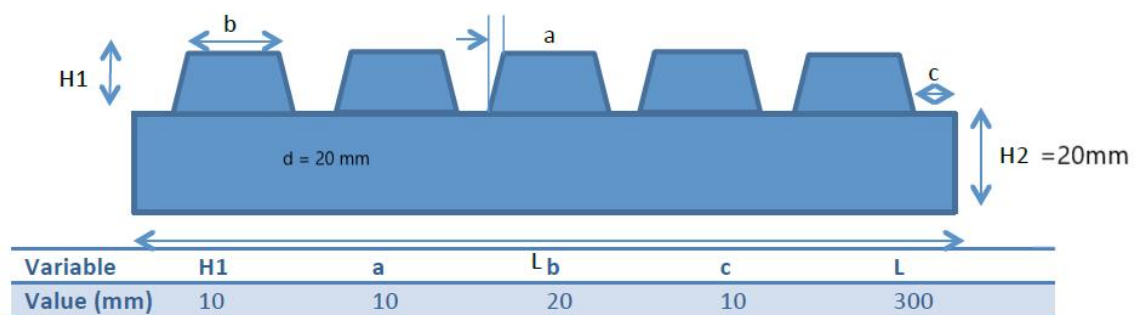

(a) Design A

The dimension H2 here needs to be calculated considering the constant material volume condition. So, from dimensions of the mat we know that the volume of the elastomeric material is 300 mm x 300 mm x 25 mm. So, the dimension H2 of this design is calculated by the below equation:

$$H2 = \frac{[(300 * 300 * 25) - (0.5 * (b + (b + 2a))) * 300]}{300 * 300}$$

The value of H2 calculated is 20 mm.

For this design, numerical analysis was done by using the tie constraint. The surface to surface interaction failed for this design as no results were obtained by using this interaction. May be, more fine mesh would have been required to analyse by using surface interaction but since the student edition of Abaqus CAE is limited only to 1000 nodes it gave errors for computation. The error received was 'too many attempts made for this increment'. So, here we had to use the symmetry of the geometry of mat. We analysed only one-fourth portion of the mat as the load distribution was uniform over the contact area.



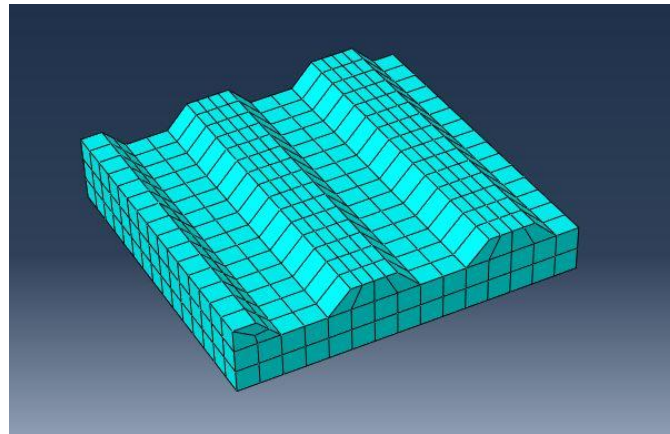

Using symmetry of the mat geometry

Below figures show the contour plot for variation of stress values and variation of displacement for the elastomeric mat Design A by using tie constraint.

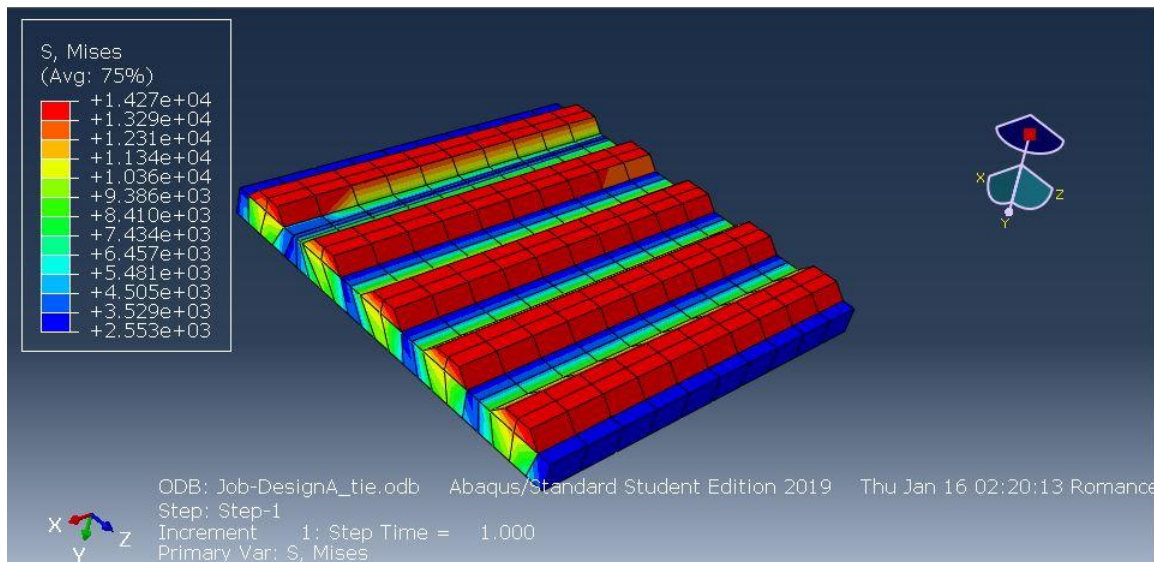

Von Mises stress contour for Design A

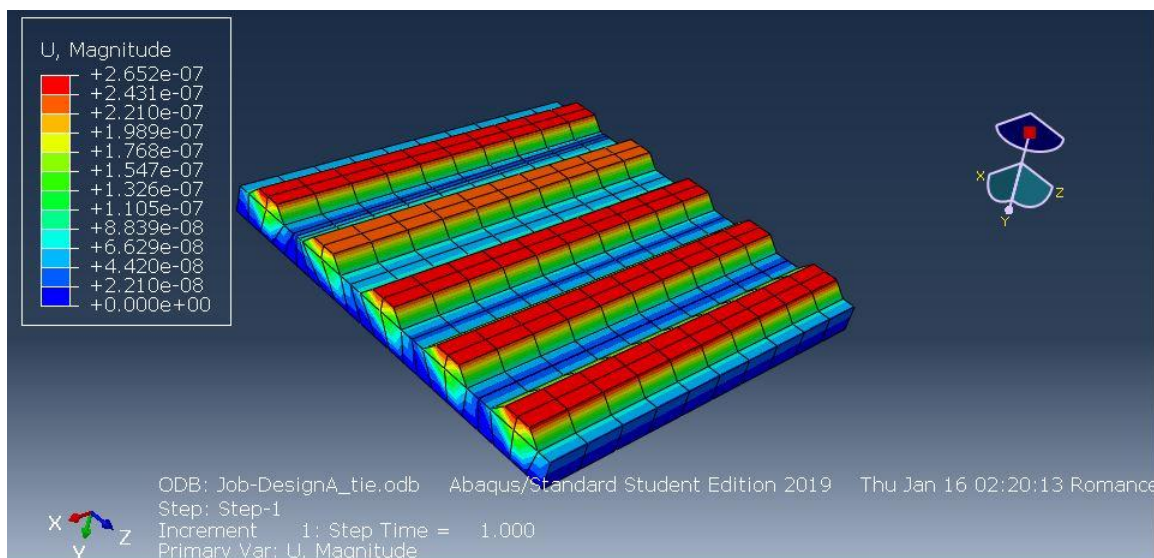

Displacement contour for Design A

The maximum value of von Mises stress obtained is  $1.427e+04$  Pa. The value of displacement obtained from the U plot for tie constraint over the time is  $2.652e-07$  m. The value of stiffness obtained in this case is  $0.0538$  KN/mm<sup>3</sup>.

- Design B:

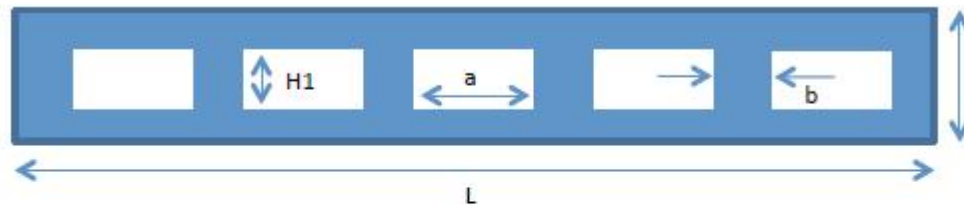

Variable	H1	a	b	L
Value (mm)	15	20	20	300

(b) Design B

The dimension H2 for this design has been calculated by using the equation:

$$H2 = \frac{(300 * 300 * 25) - (5 * a * H1 * 300)}{300 * 300}$$

The value of H2 calculated is 30 mm.

For this design, numerical analysis was done by using the tie constraint. A small change in geometry was done for this design. This change did not affect anything critical. Because of the limitation of the student version of Abaqus CAE fine mesh was not possible to achieve. In this design, the gap between the slots was 20 mm only, which was quite small and hence small mesh size needed to be selected. But this led to increased number of nodes for the design. Due to limitation the nodes couldn't be increased. Also, because of such a small gap between the slots the mesh patterns observed were irregular in the area surrounding the slots, as shown below.

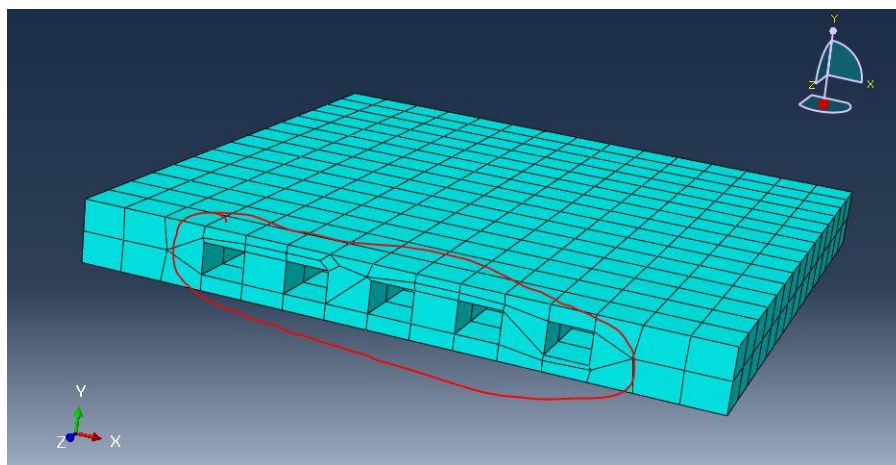

Irregular mesh patterns observed around slots

So, as a solution in this case, the gap between the slots was increased from 20 mm to 40 mm. Because of this, the decent mesh quality was achieved with average size of the mesh element.

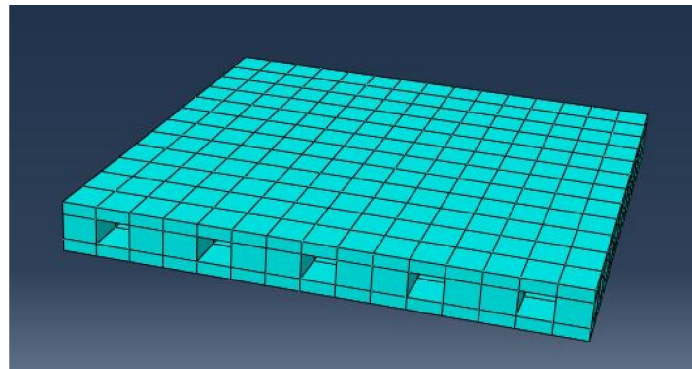

Decent mesh quality due to design change

Shown below is the change made in the geometry in order to run the analysis with the given limitations. Only the value of  $b$  is changed from 20 mm to 40 mm, rest all dimensions remain the same.

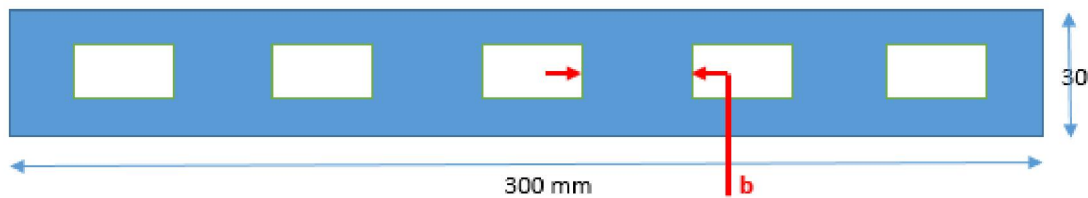

Below figures show the contour plot for variation of stress values and variation of displacement for the elastomeric mat Design B by using tie constraint.

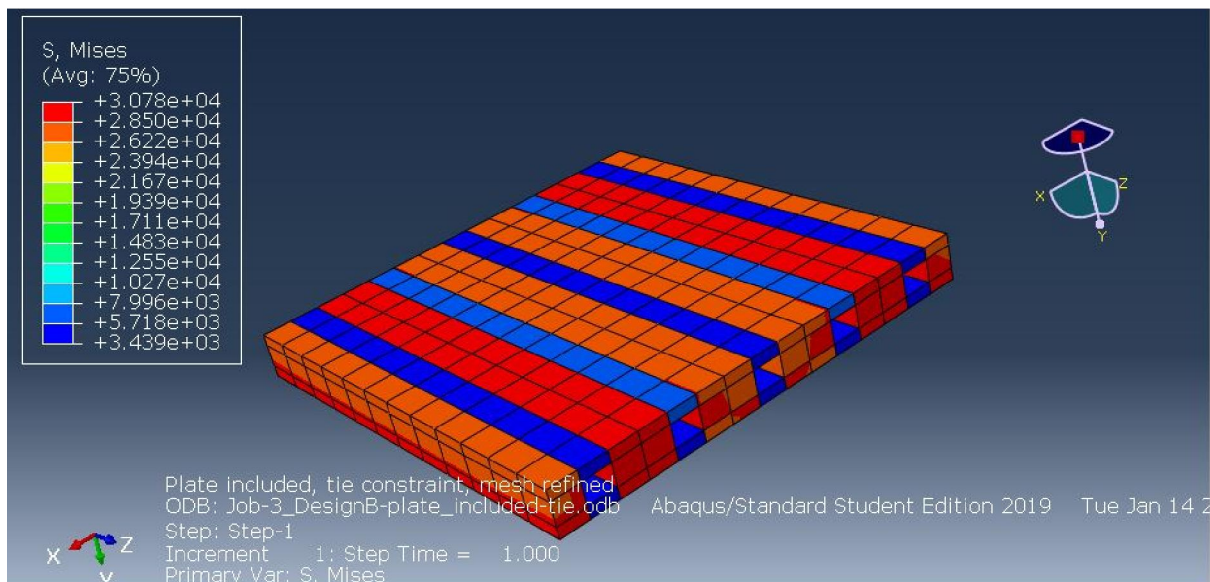

Von Mises stress contour for Design B

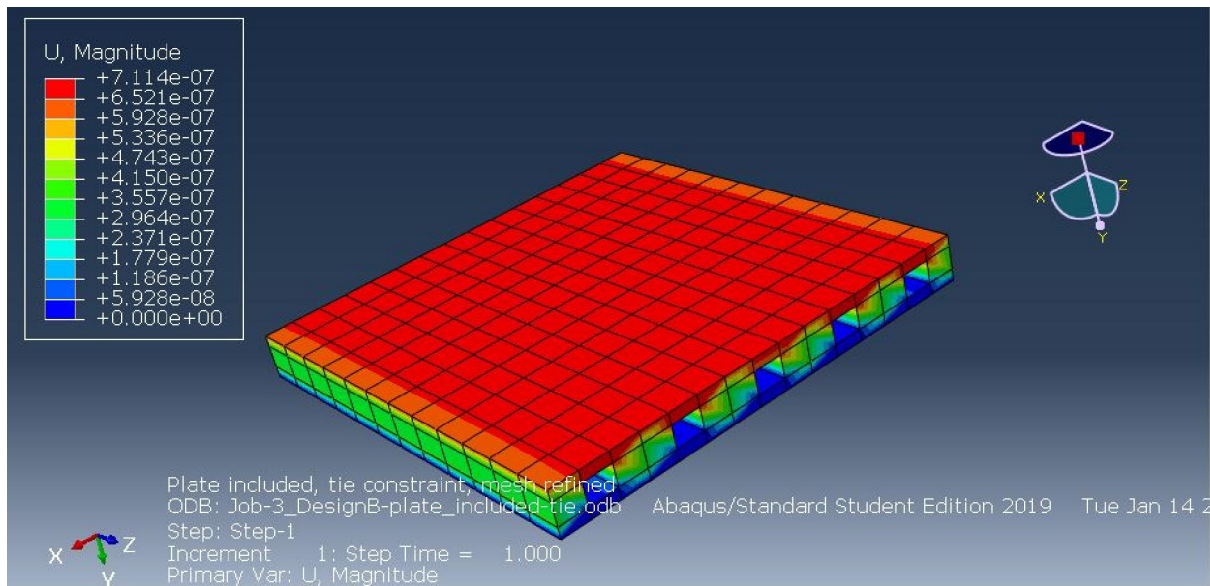

Displacement contour for Design B

The maximum value of von Mises stress obtained is  $3.078 \times 10^4$  Pa. The value of displacement obtained from the U plot for tie constraint over the time is  $7.114 \times 10^{-7}$  m. The value of stiffness obtained in this case is  $0.0432 \text{ KN/mm}^3$ .

- Comparison between the stiffness:

All the observations have been analysed by using the tie constraint for the designs. It is observed that the stiffness of Design A is higher than the other 2 designs while the stiffness of Design B is the lowest. An important reason which can be considered here the area of contact between the plate and the mat. As the area of contact decreases, the stiffness is seen to increase. The same applies in our cases also. Since design A has less area of contact with the upper plate, the stiffness value obtained is more than the other designs. Design B gives a less stiffness value on account of its geometry. The slots provided in the design make the design weak. Stress concentrations can be observed around the slots. So, concluding with respect to the static analysis, design A yielded better results for stiffness. The below table shows the comparison between the values of Stresses, displacements and stiffness obtained for all 3 designs.

	Design	Stress (e+4)	Disp (e-7)	K
<b>Static Tie</b>	OO	2.015	3.886	0.0518
	A	1.427	2.652	0.0538
	B	3.078	7.114	0.0432

### ✚ Task 3 - Dynamic Response analysis of the 3 designs

After the Static analysis, dynamic response of the elastomeric mat was analysed. Here, we check whether the results obtained in static analysis are consistent with the dynamic results or not. Now, along with the static load, the dynamic load was also added in a new step. The dynamic load used is given by:

$$\sigma(t) = \sigma_0 + \sigma_d \gamma \sin(2\pi ft)$$

A periodic amplitude is applied between 0 to 1 interval with a circular frequency of 31.4 Hz. The dynamic load is  $\sigma_d = 10000 \text{ N/m}^2$  and has an amplification factor of 1.4 for a frequency of 5 Hz. Hence, after calculations the dynamic load to be applied in the step becomes  $14000 \text{ N/m}^2$ . And the total load considered here is the static load in previous step plus the dynamic load in this step.

After applying the dynamic load, the stress and displacement contours were plotted and the stiffness were calculated for the 3 designs.

- Design 00 (Initial Design):

Below figures show the contour plot for variation of stress values and variation of displacement after applying dynamic load for the elastomeric mat Design 00 by using tie constraint.

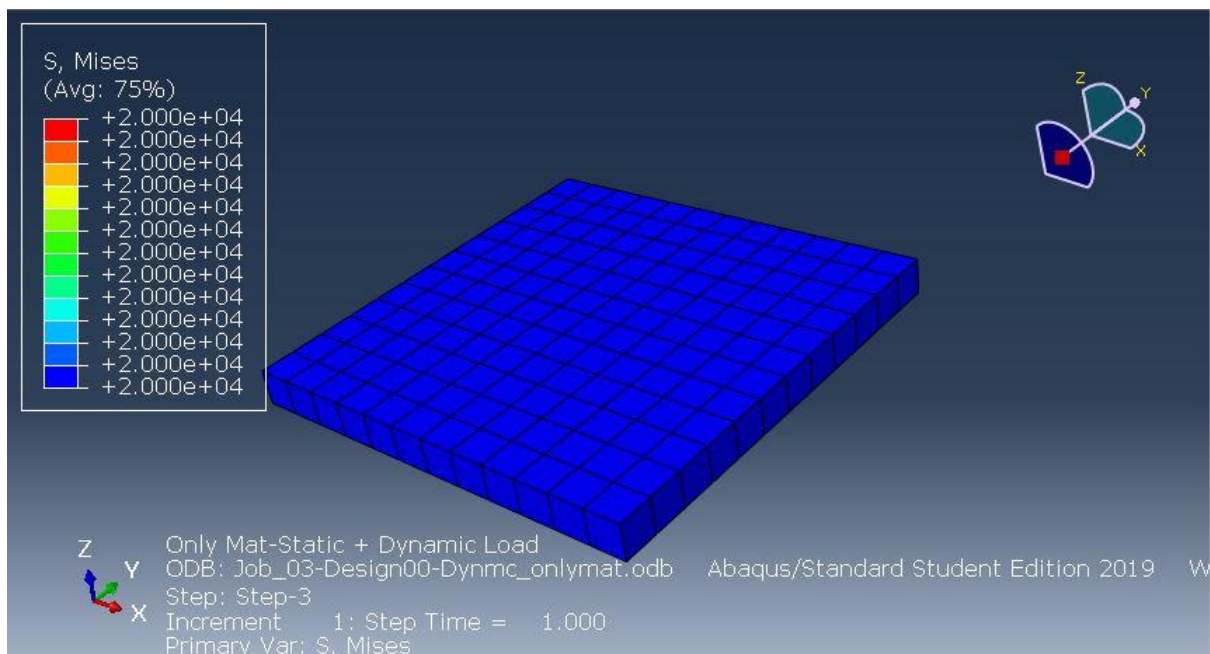

Von Mises stress contour for Design 00 – Dynamic Loading

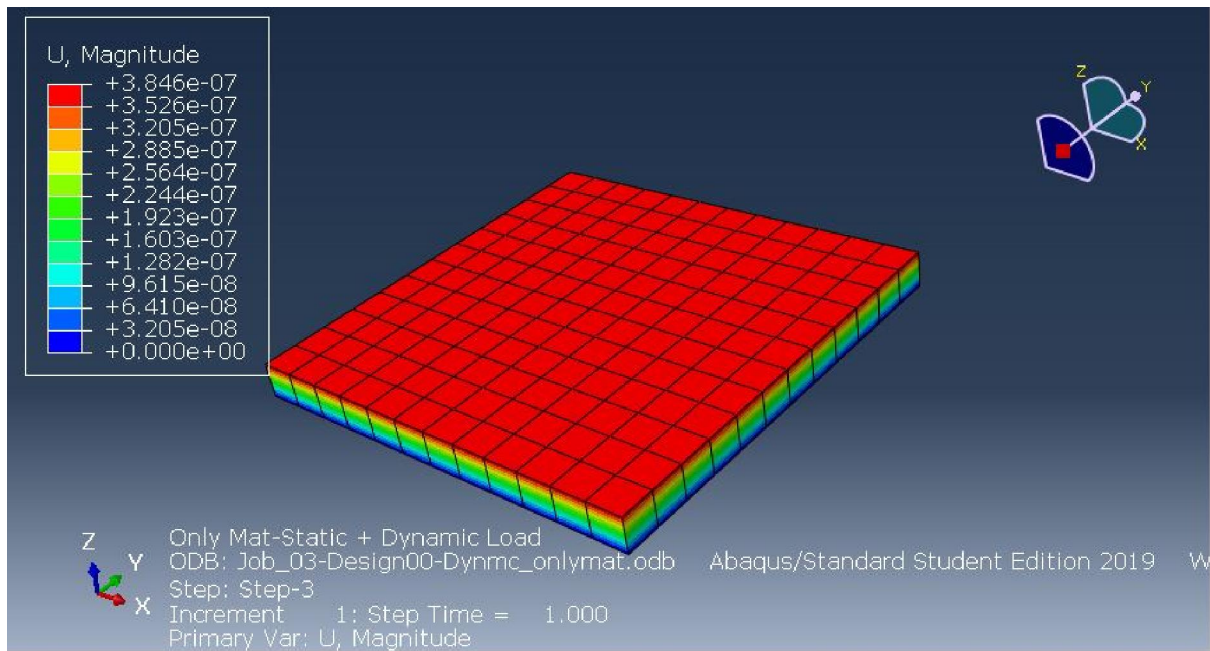

Displacement contour for Design 00 – Dynamic Loading

The maximum value of von Mises stress obtained is  $2.000e+04$  Pa. The value of displacement obtained from the U plot for tie constraint over the time is  $3.846e-07$  m. The value of stiffness obtained in this case is  $0.0518 \text{ kN/mm}^3$  which matches with the results obtained in the static analysis.

- Design A:

Below figures show the contour plot for variation of stress values and variation of displacement after applying dynamic load for the elastomeric mat Design A by using tie constraint.

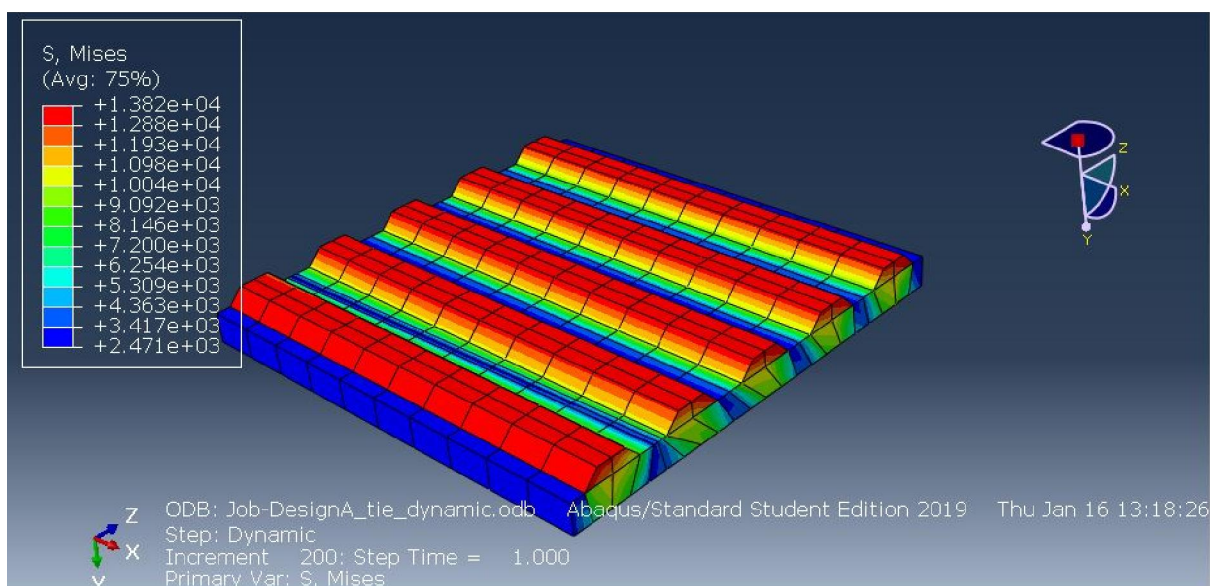

Von Mises stress contour for Design A – Dynamic Loading

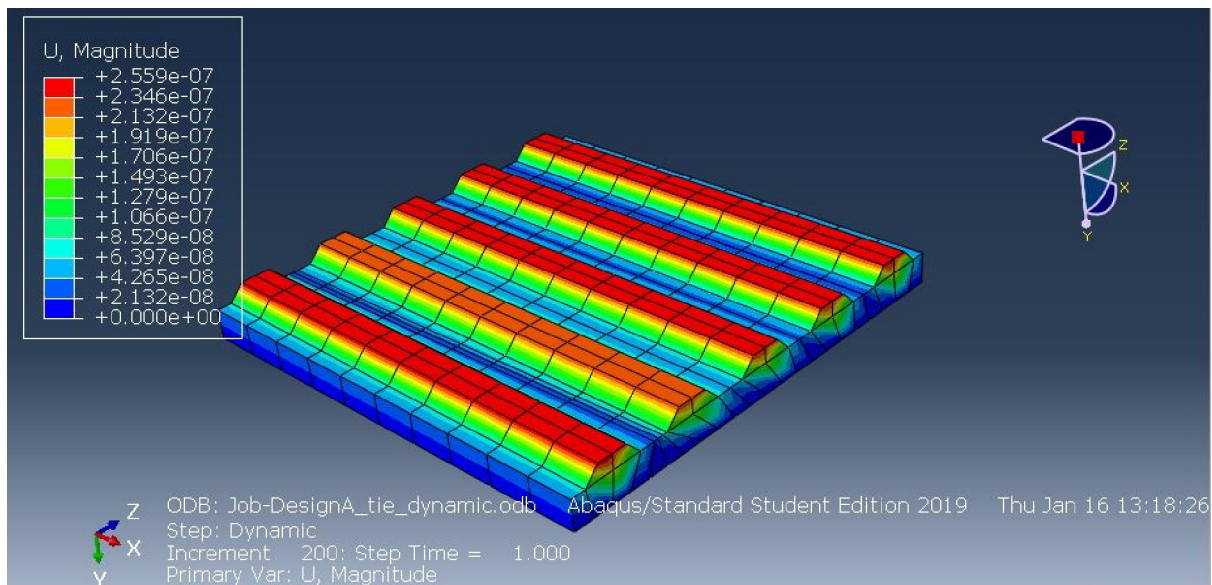

Displacement contour for Design A – Dynamic Loading

The maximum value of von Mises stress obtained is  $1.382e+04$  Pa. The value of displacement obtained from the U plot for tie constraint over the time is  $2.559e-07$  m. The value of stiffness obtained in this case is  $0.054$  kN/mm<sup>3</sup> which approximately matches with the results obtained in the static analysis with negligible error.

- **Design B:**

Below figures show the contour plot for variation of stress values and variation of displacement after applying dynamic load for the elastomeric mat Design B by using tie constraint.

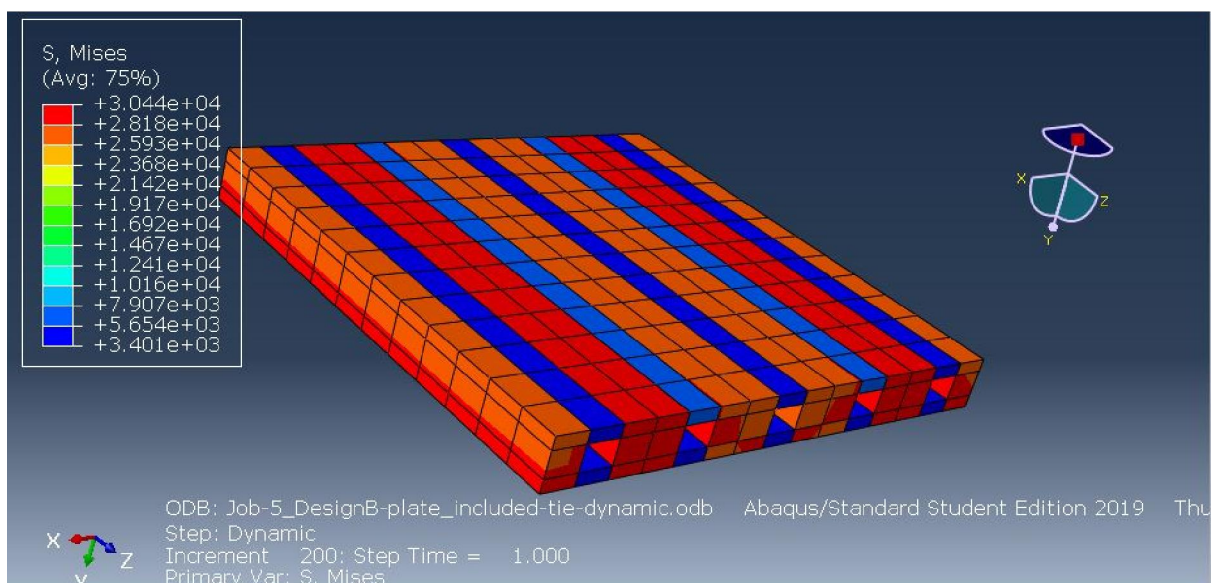

Von Mises stress contour for Design B – Dynamic Loading

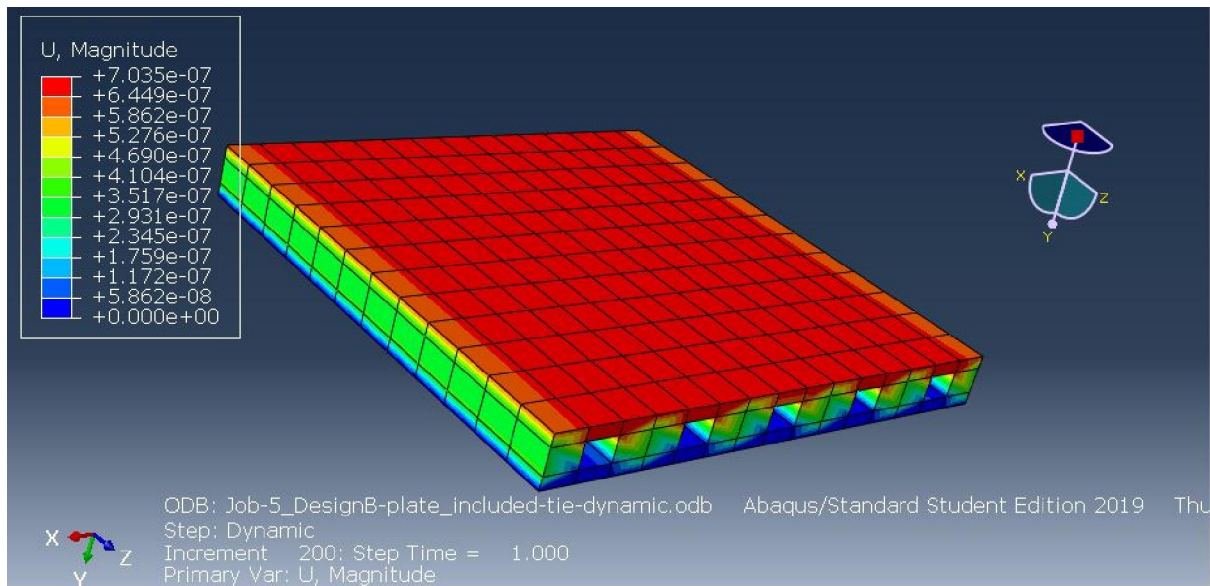

Displacement contour for Design B – Dynamic Loading

The maximum value of von Mises stress obtained is  $3.044 \times 10^4$  Pa. The value of displacement obtained from the U plot for tie constraint over the time is  $7.035 \times 10^{-7}$  m. The value of stiffness obtained in this case is  $0.0432 \text{ kN/mm}^3$  which matches with the results obtained in the static analysis.

- Comparison Table:

Shown below is a table having the values of stresses, displacements and stiffness for all the 3 designs.

	Design	Stress (e+4)	Disp (e-7)	K
Dynamic Tie	OO	1.993	3.843	0.0518
	A	1.382	2.559	0.054
	B	3.044	7.035	0.0432

It is observed that the results are consistent with the static analysis values. Design B has the lowest stiffness value while Design A emerges to be a good design of all.



- Displacement vs Time plots for the 3 design cases:

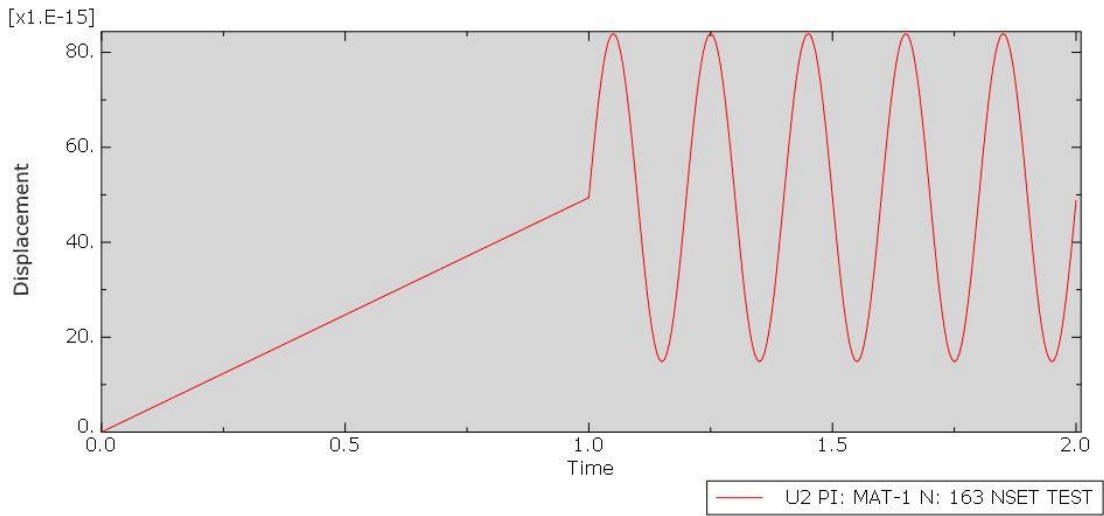

Displacement vs Time plots - Design00

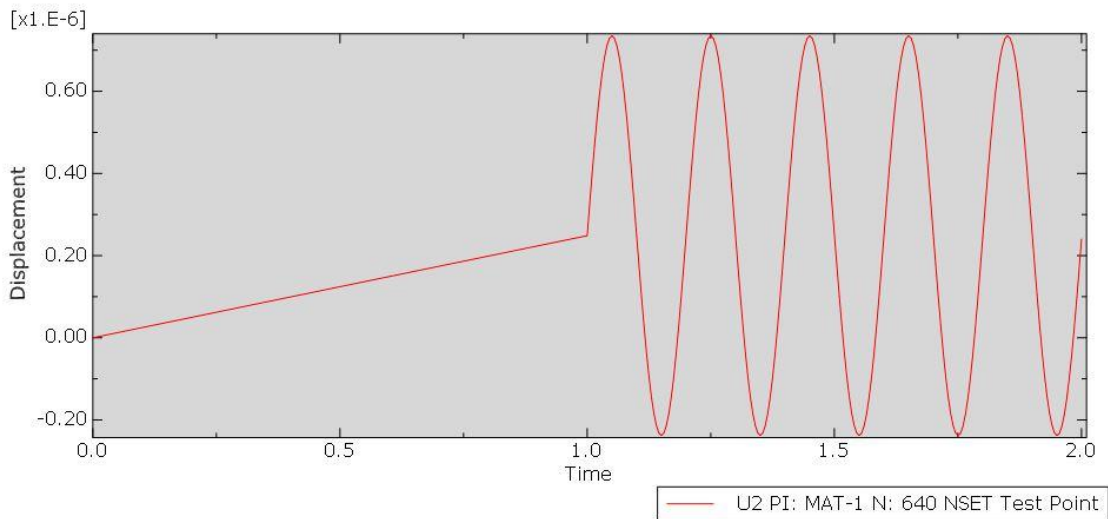

Displacement vs Time plots - Design A

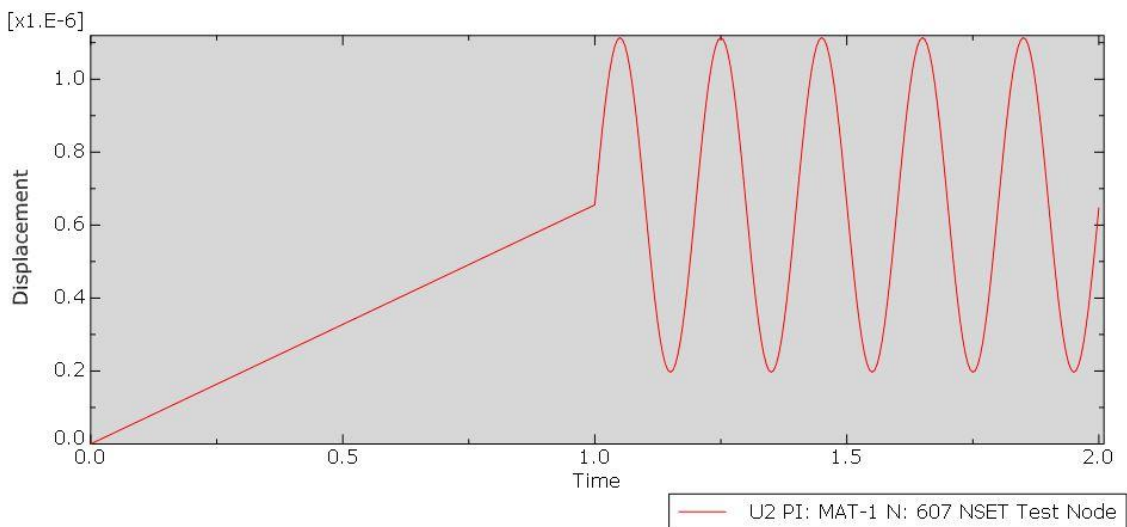

Displacement vs Time plots - DesignB

## ✚ Task 4 – Conclusion and Modifications

In this study, three different designs of the elastomeric mat used in railways were analyzed for their stiffness. The design which gave more stiffness value was termed to be more efficient than the other two. The most important assumption considered was the constant volume condition, i.e the volume of the elastomeric mat should remain the same in all the design cases.

Initially, a simple design (Design00) was analyzed and it showed that the stiffness calculated analytically for this design matched with the numerical stiffness computed using the surface to surface contact interaction. There was 0.4% difference between the stiffness values obtained by tie constraint and surface interaction for this design.

However, inspite of the exact results shown in the initial design case by the surface to surface interaction as compared to the analytical values, still tie constraint was used for the analysis of the other 2 designs because of the reasons explained in the design cases. For design A, using the surface to surface interaction showed no results because of errors received. The errors were due to too many incremental attempts made for a certain mesh size because of the limitation on the number of nodes for the student version of Abaqus CAE. The surface interaction, may be, needed more finer mesh in order to run the analysis. Also, for Design B, lower mesh sizes were needed to be used on account of the small geometry of the design. Therefore, small changes were made in the gaps between the slots which did not affect the overall dimensions of the design. The goal was to try to achieve a fine mesh. Hence, all the analysis comparisons have been done by using the tie constraint.

But still, if software limitations were not imposed then may be surface to surface interaction would yield good results because the contact between surfaces is more rigid and tight in surface interaction than in tie constraint. So, for this analysis using the tie constraint, design A proved to have a good stiffness than other 2 designs. The reason for this is that, as the surface contact is reduced between the surfaces in contact, the stiffness tends to increase. Since, in design A the area of contact was less as compared to other two designs, a higher stiffness value was seen in design A. Stresses and displacements were most observed in design B and hence it had the lowest stiffness value.

With the static results, the dynamic analysis also showed the consistency of results with the static case. The results of stiffness for these designs are shown below:

K values	Static Analysis	Dynamic Analysis
Design 00	0.0518	0.0518
Design A	0.0538	0.054
Design B	0.0432	0.0432

New modifications in the designs can also be made by considering some factors such as reduction in the contact area helps to increase the stiffness. With this thing in mind we thought of making a model for elastomeric mat like this one.

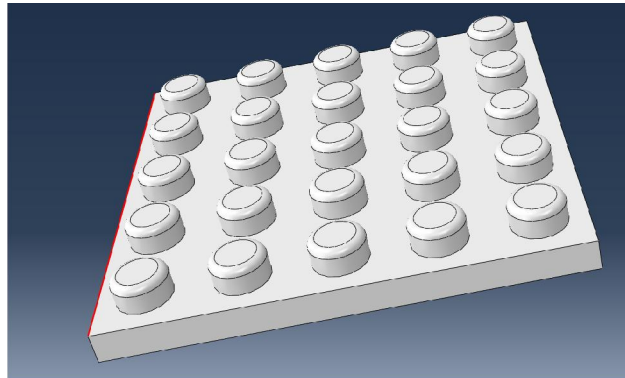

In this design, we have tried to decrease the area of contact between the mat and steel plate, so that the stiffness of the plate can be increased as per the fact that stiffness is inversely proportional to the contact area. The small cylinders' edge extruded has been filleted to avoid stress concentration near the edges and there is smooth flow of load.

Due to short of time, we were not able to provide the simulated results also for this design, but from the theories and whatever results we have got it is evident that reduction in contact area would have a great impact on the design efficiency. We tried meshing this new design but simulation couldn't be done because of node limit of student version and lack of time. Many more modifications can be made than this one in future for this elastomeric mat.

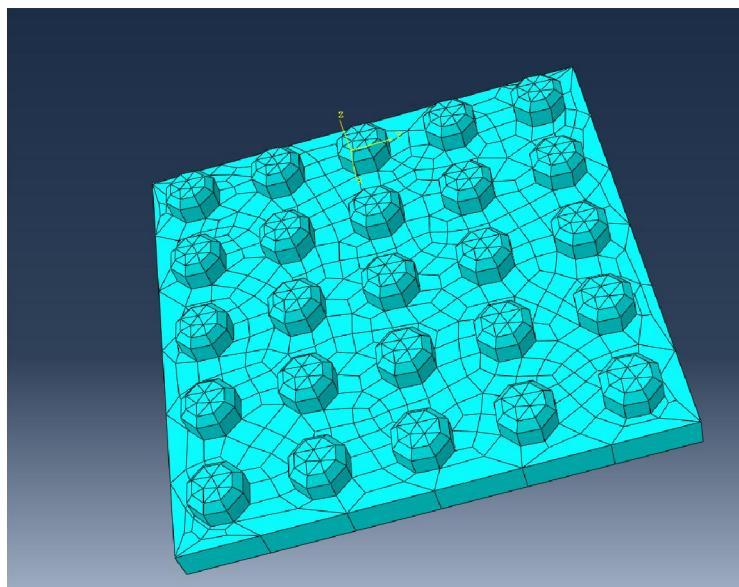

Meshed model of new design

## Appendix

The distribution of project work has been mentioned in this section.

This project was divided among 2 members Kiran Kolhe and Prakhar Rastogi.

- Kiran:
  - Static analysis of numerical stiffness using tie constraint and surface to surface interaction for the initial design of mat (Design 00).
  - Static Analysis and geometry development of Design B.
  - Dynamic Analysis of initial design (Design 00).
  - Dynamic Analysis of Design B.
  - Displacement time plots of all designs.
  - Conclusions of the project.
  - Report preparation of the project.
  
- Prakhar:
  - Calculation of analytical stiffness for the initial design of mat (Design 00).
  - Comments on using Tie constraint and Surface to surface interaction.
  - Static Analysis and geometry development of Design A.
  - Dynamic Analysis of Design A.
  - Development of new design modification and comments.
  - Presentation preparation of the project.