



Computational Structural Mechanics and Dynamics

Practice 3

Berna Eraslan

Exercise 1

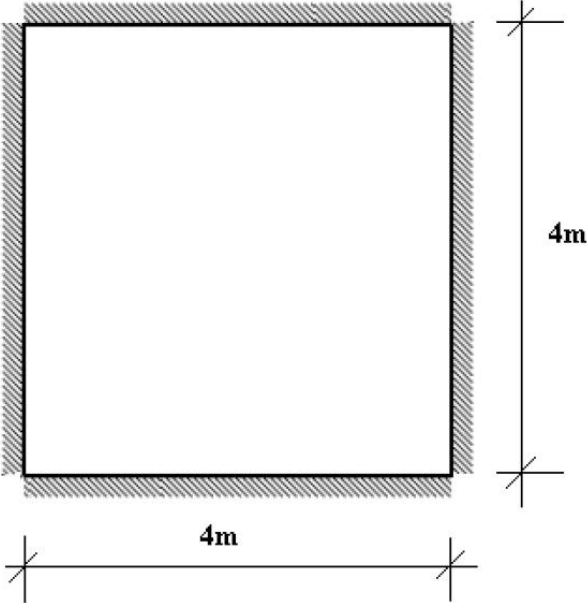

Analyze the state of stress of the quadratic plate in the figure, whose four sides are clamped. The plate is submitted to a uniform load q . Use triangular plate elements DKT, triangular Reissner-Midlin elements with 6 nodes with reduced integration and quadrilateral elements CLLL for the analysis. Compare the obtained results for the deflection in the center of the plate with the analytical solution.

First, CLLL mesh is shown in Figure 2.

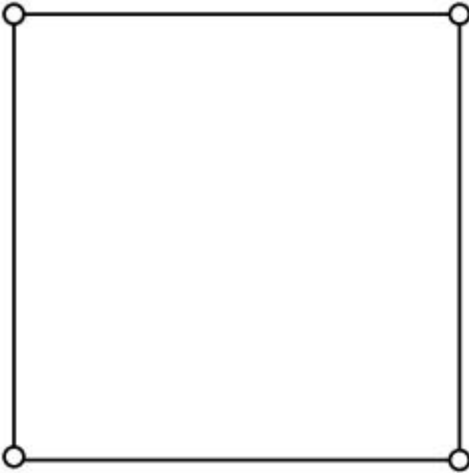

Figure 1. Normal Quadrilateral 4 nodes



Figure 2. CLLL Mesh

Results

The results are presented in Figure 3, Figure 4 and Figure 5.

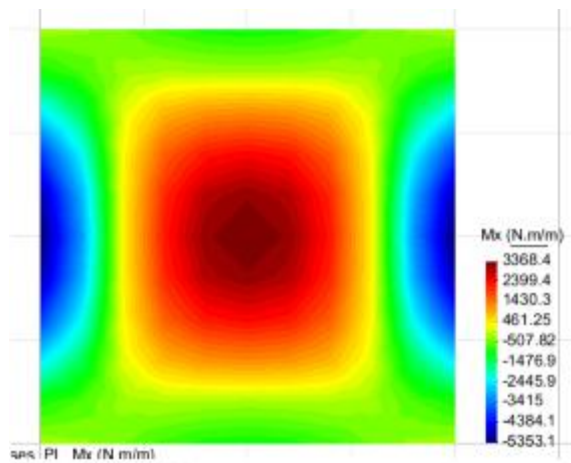

Figure 3. Stresses M_x

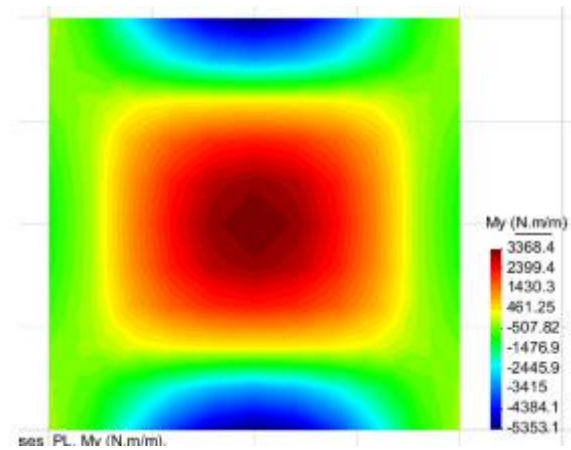

Figure 4. Stresses M_y

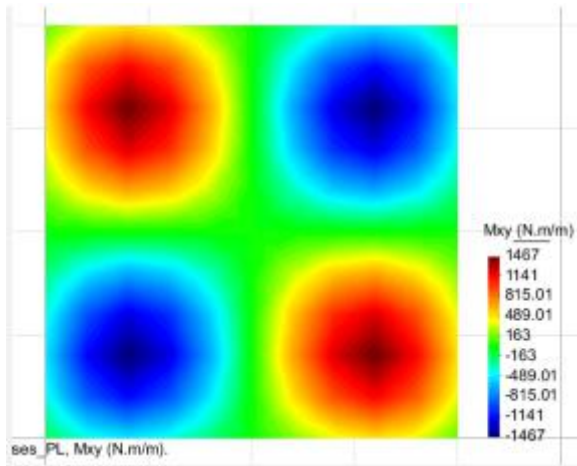

Figure 5. Stresses M_{xy}

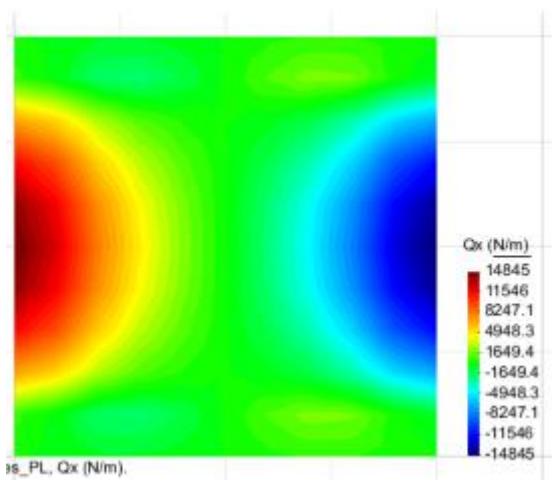

Figure 5. Stresses Q_x

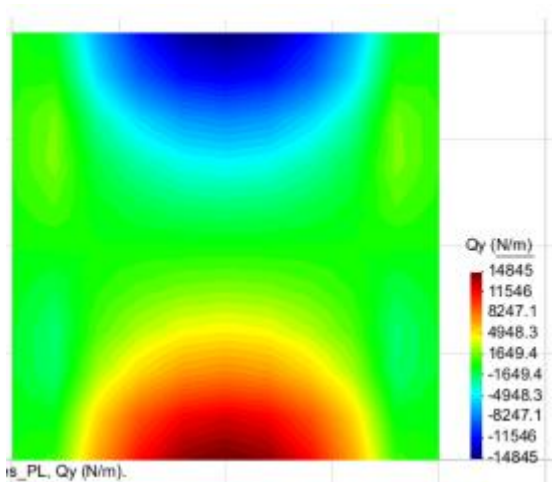

Figure 7. Stresses Q_y

- DKT ELEMENT

DKT mesh is presented in Figure 8.

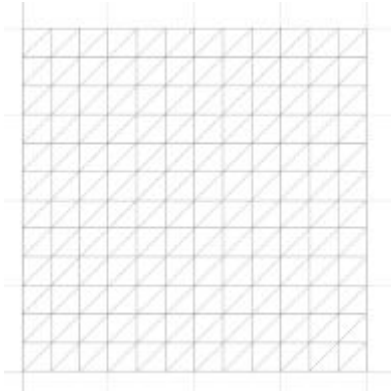

Figure 8. DKT Mesh

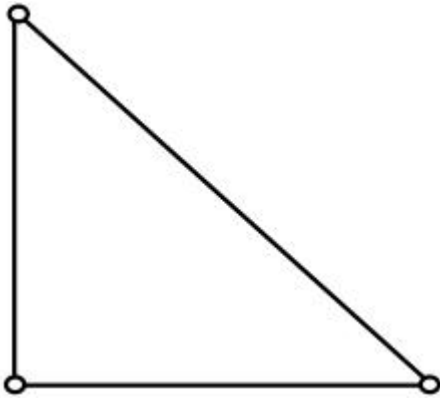

Figure 9. 3 Nodes Triangle

RESULTS

The results for DKT element are presented in the following figures.

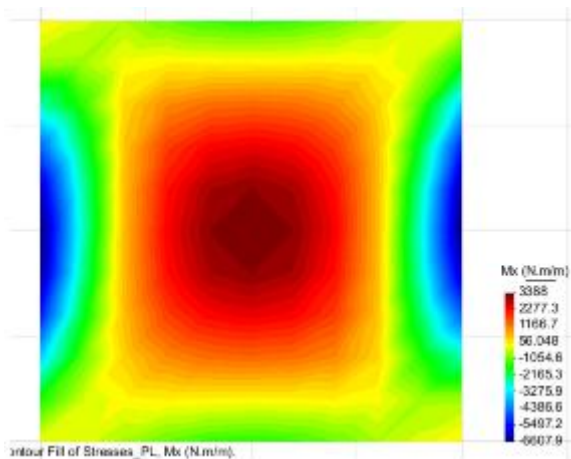

Figure 10. Stresses Mx

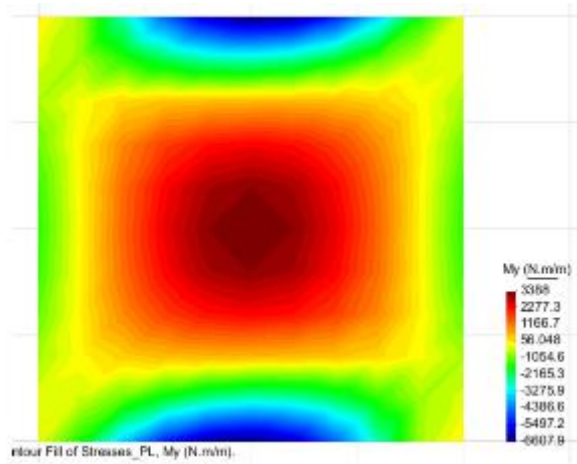

Figure 11. Stresses My

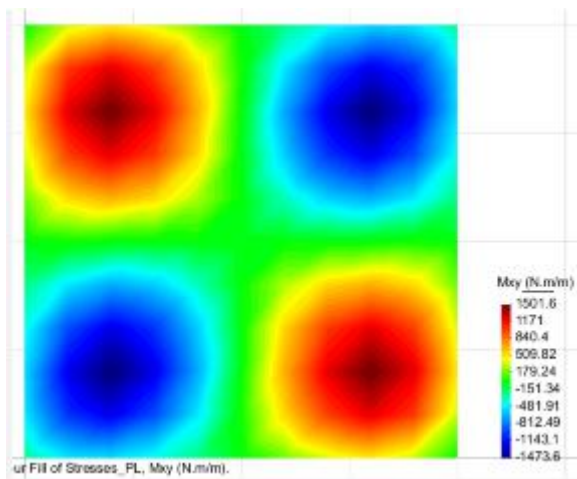

Figure 12. Stresses Mxy

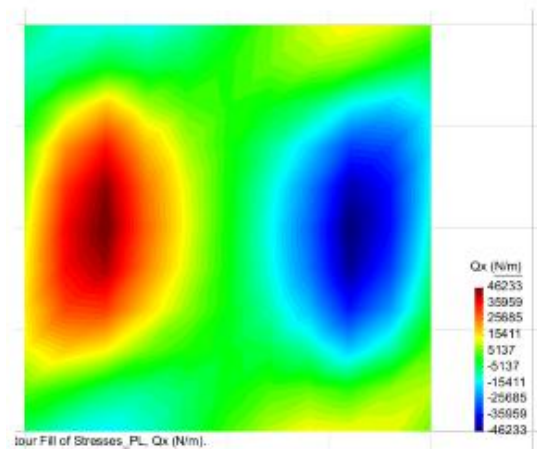

Figure 13. Stresses Qx

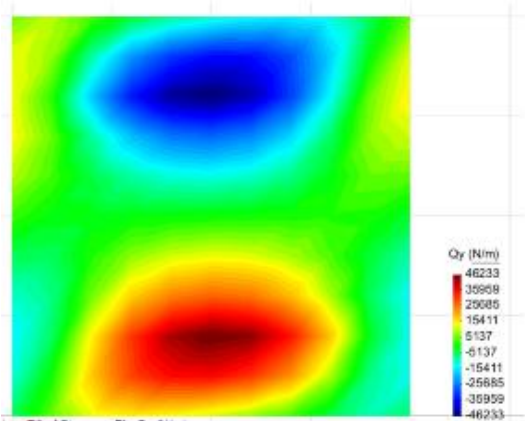

Figure 14. Stresses Q_y

- RM ELEMENT

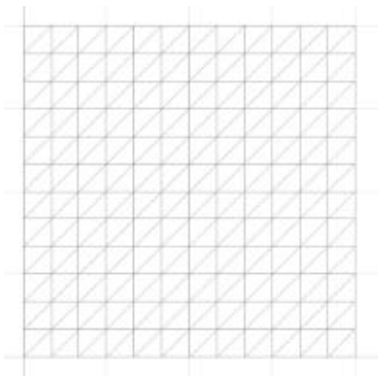

Figure 15- RM mesh

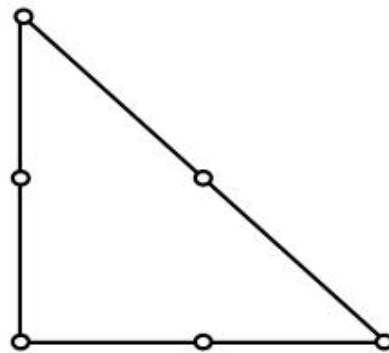

Figure 16- Quadratic 6-nodes triangle

The results for RM element are presented in the following figures.

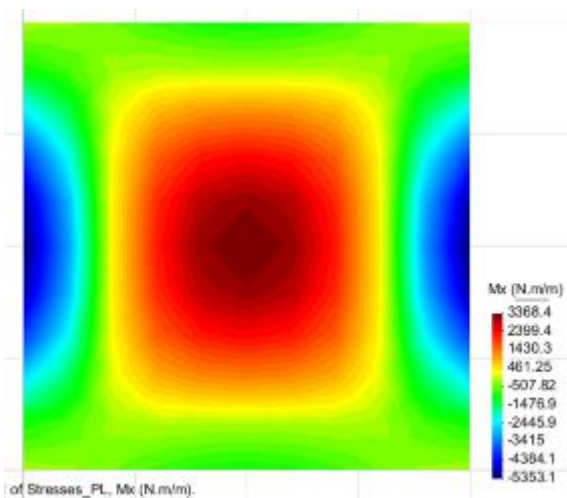

Figure 17. Stresses M_x

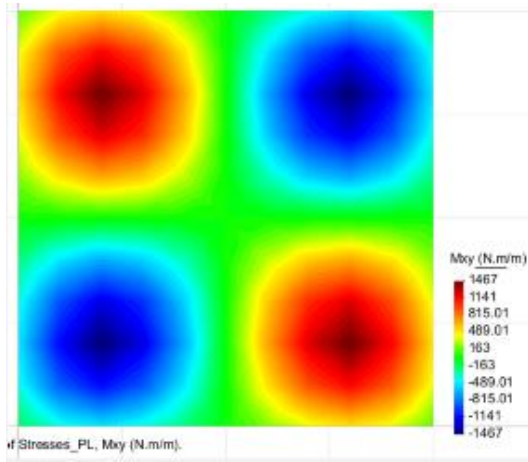

Figure 18. Stresses M_{xy}

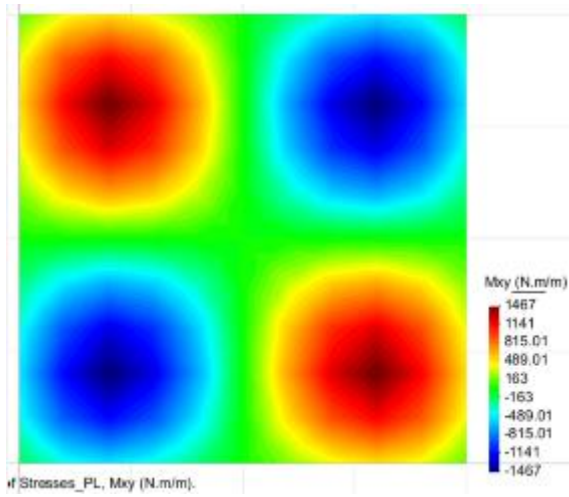

Figure 19. Stresses M_{xy}

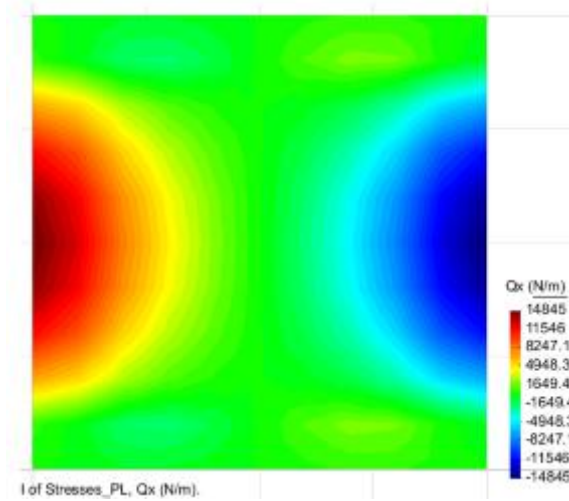

Figure 20. Stresses Q_x

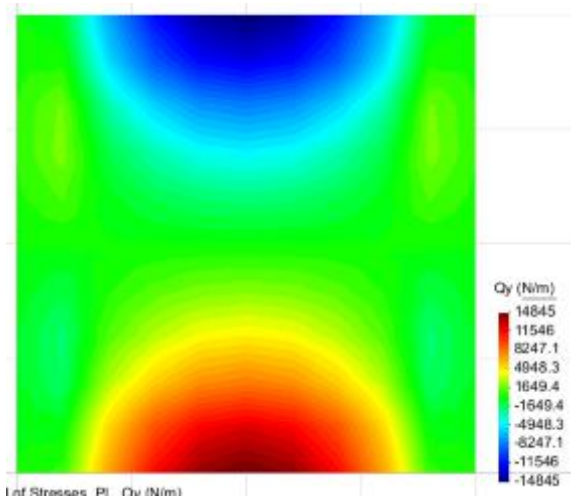

Figure 21. Stresses Qy

● ANALYSIS OF RESULTS

All results are presented in the following table.

| Stresses | CLLL element | DKT element | RM element |
|----------------|--------------|-------------|------------|
| Mx max | 3368.4 | 3388 | 3368.4 |
| Mx min | -5353.1 | -6607.9 | -5353.1 |
| My max | 3368.4 | 3388 | 3368.4 |
| My min | -5353.1 | -6607.9 | -5353.1 |
| Mxy max | 1467 | 1501.6 | 1467 |
| Mxy min | -1437 | -1473.6 | -1467 |
| Qx max | 14845 | 46233 | 14845 |
| Qx min | -14845 | -46233 | -14845 |
| Qy max | 14845 | 46233 | 14845 |
| Qy min | -14845 | -46233 | -14845 |

We observe that CLLL element and RM element have same values. On the other hand, DKT element has very close values for moment stresses; but very different results for shear.

Now, we compute the displacement analytically. In order to calculate that, we calculate flexural rigidity using the following expression:

$$D = \frac{Et^3}{12(1-\nu^2)}$$

Then we find that:

$$D=2.6 \text{ MNm}$$

$$\delta = \frac{\alpha q l^4}{D}$$

We compute the deflection at the center of the plate obtaining the $d=1.24 \text{ mm}$.

The result displacements from software are presented in the following table.

| Element type | CLLL element | DKT element | RM element |
|-----------------------|--------------|-------------|------------|
| Max displacement (mm) | 1.25 | 1.26 | 1.24 |

The max displacements in elements occur at the center and we observe that in all cases we got same results.

EXERCISE 2

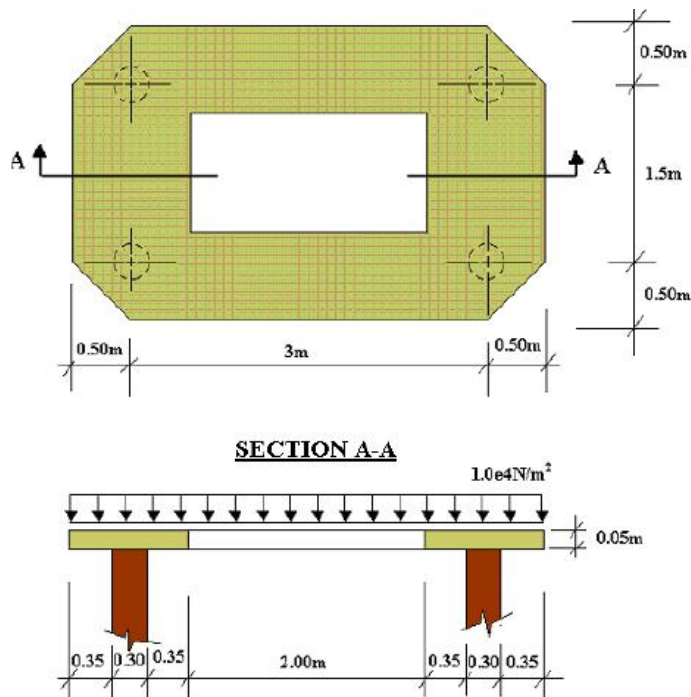

Data

$$\text{Steel} \begin{cases} E = 2.1 \times 10^{11} \frac{\text{N}}{\text{m}^2} \\ \nu = 0.3 \\ \gamma = 7.80 \times 10^4 \frac{\text{N}}{\text{m}^3} \end{cases}$$

The figure shows a steel plate supported on four columns. Analyze the structural behavior of the plate using the theory of thin plates. Use triangular elements DKT .

First, we start with the mesh. It is presented in Figure 22.

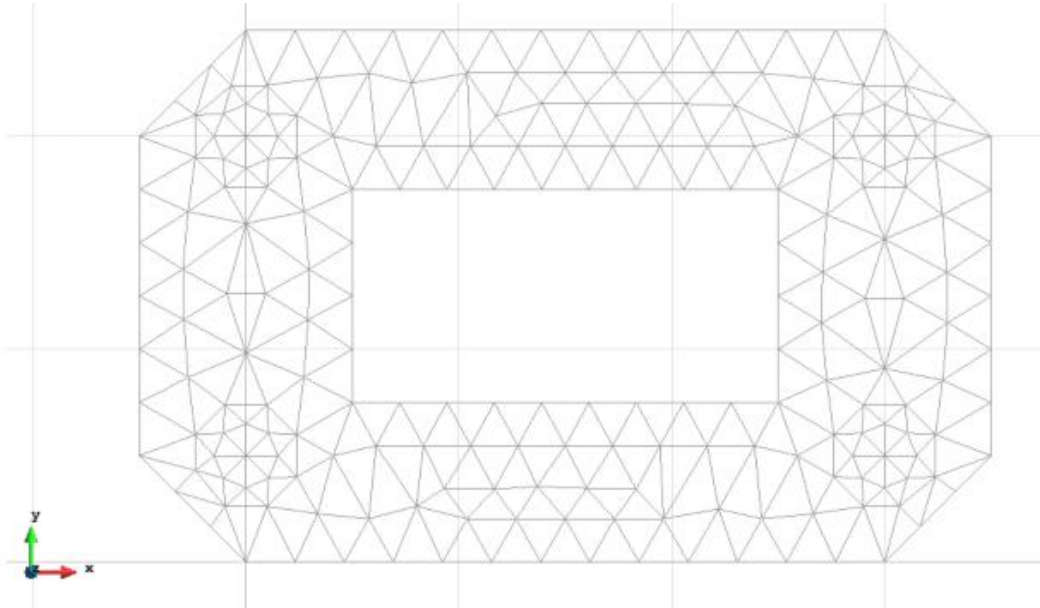

Figure 22.Mesh

The result for displacement is shown in Figure 23.

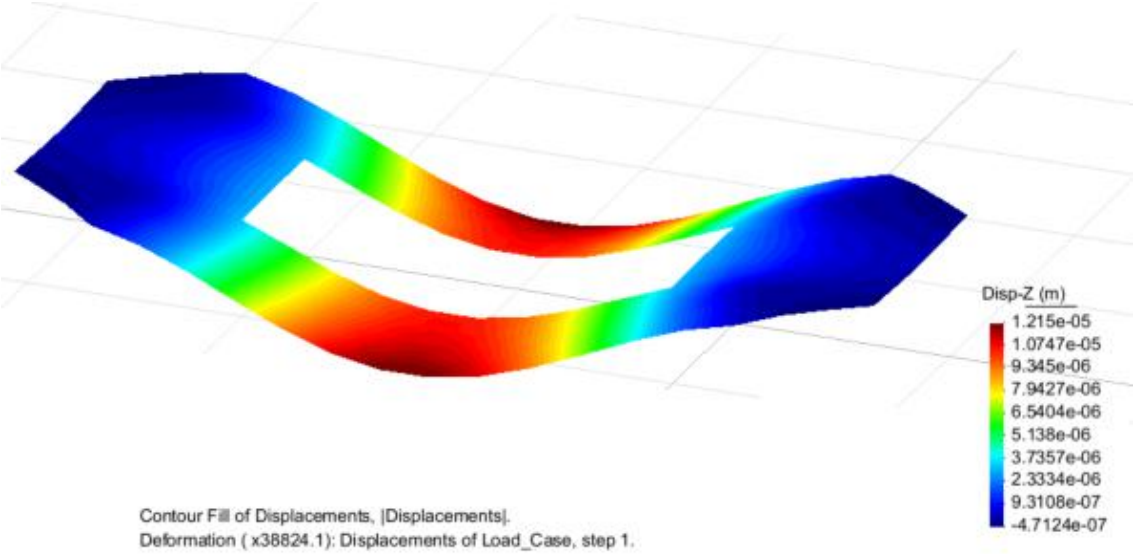

Figure 23.Displacement

- Analysis of results:

We observe that the maximum deflection occurs in the middle of the plate. On the other hand we see an upward deflection at the edges; therefore we say that it proves that the applied theory of thin plate is an adequate approach.

→The results for bending moments M_x , M_y are presented in Figure 24 and Figure 25.

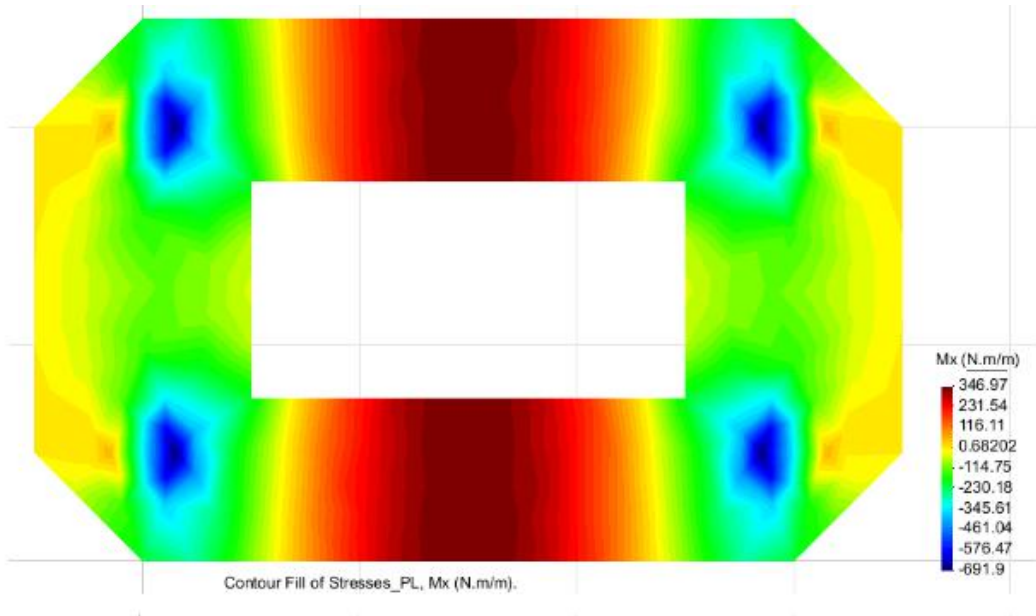

Figure 23.Moment M_x

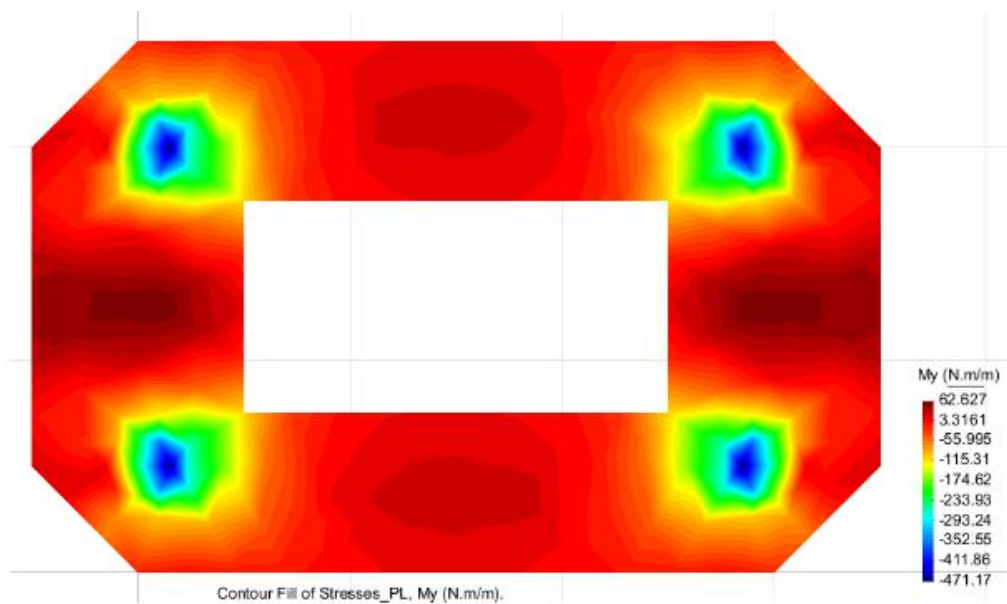

Figure 24.Moment M_y

- Analysis of results:

We see that the moment is minimal at the free edges. On the other hand, negative moments are the largest at the supports. Positive moment increases as we move away from the supports.

→The results for shear stresses are presented in Figure 25 and Figure 26.

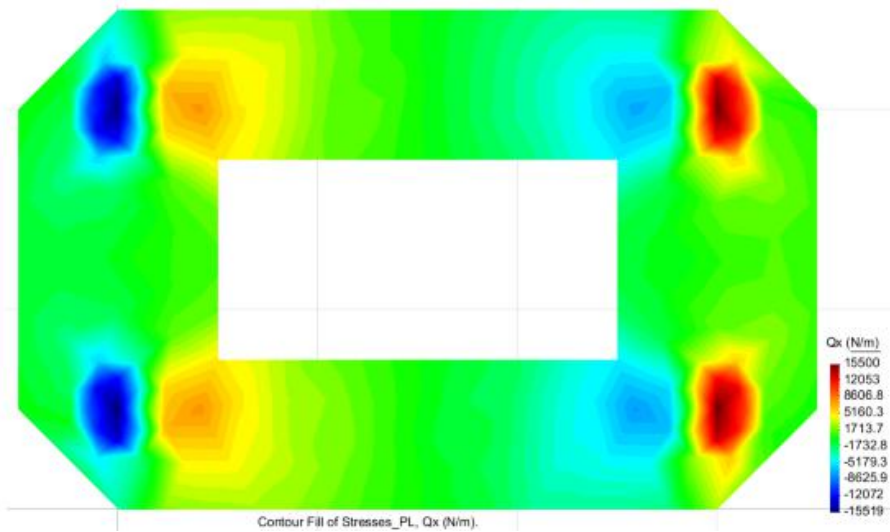

Figure 24. Shear Stresses Q_x

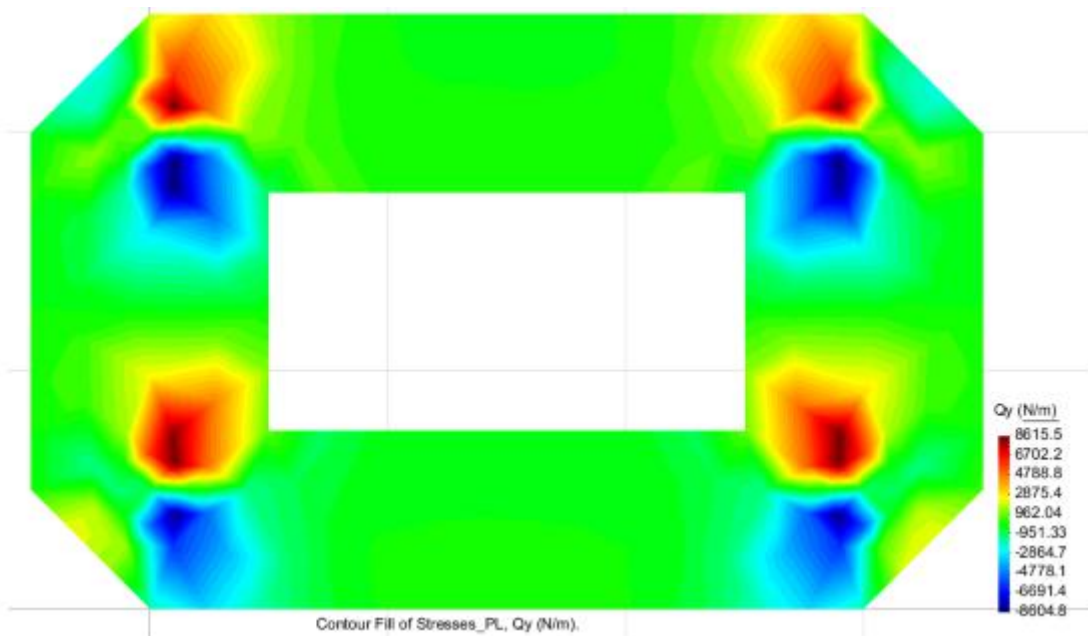
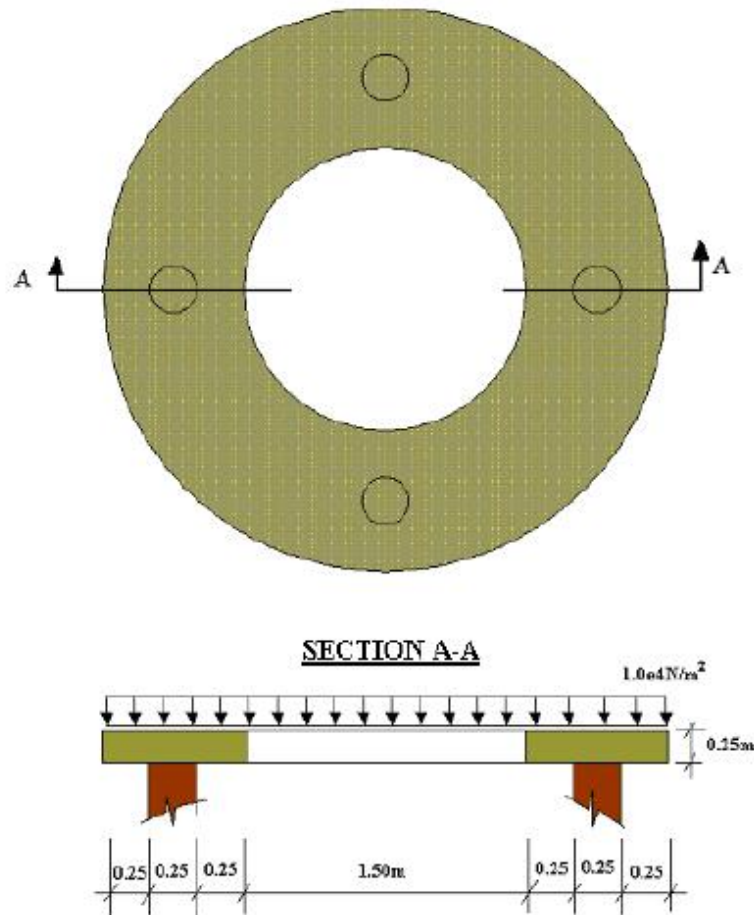

Figure 25. Shear Stresses Q_y

- Analysis of results:

We see a transition from negative to positive shear stress occurring over the supports. We can say that this is a typical behavior for plate supported this way. Moreover, we can say that is related to the different displacements that occurs before and after the supports.

EXERCISE 3



Data

$$\text{Concrete} \begin{cases} E = 3.0e10 \frac{\text{N}}{\text{m}^2} \\ \nu = 0.2 \\ \gamma = 2.4e4 \frac{\text{N}}{\text{m}^3} \end{cases}$$

The figure shows a reinforced concrete plate supported on four columns, submitted to its dead weight and a uniform load. Analyze the structural behavior using the theory of thick plates of Reissner-Mindlin. Use triangular elements of Reissner-Mindlin with six nodes and reduced integration.

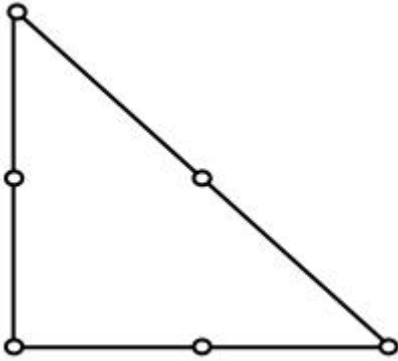

Figure 26. RM 6 nodes triangle

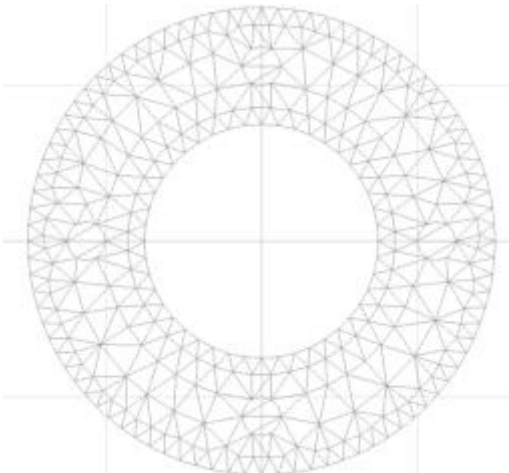

Figure 27. Mesh

Now, we analyze the structure using RM with 6 nodes.

Result for displacement are presented in Figure 28.

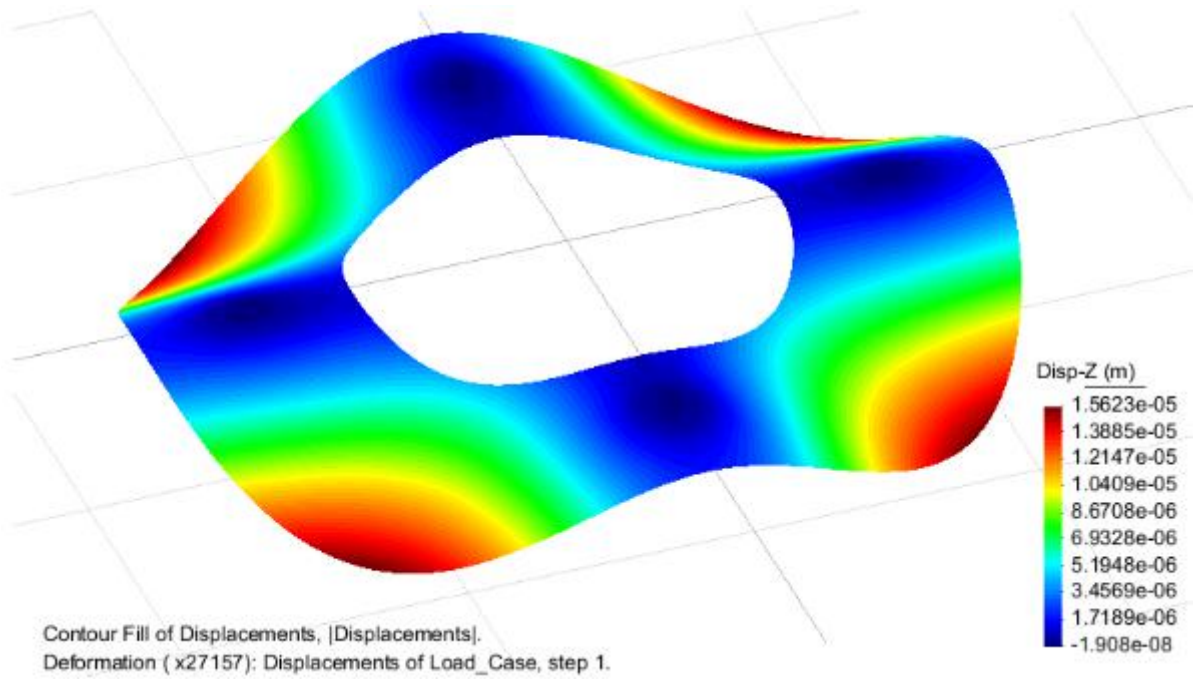

Figure 28. Displacement in Z direction

We observe that the maximum deflection occurs on the edges. Moreover, we see some minimal upward deflection on the pillars.

The results for moments are shown in Figure 29 and Figure 30.

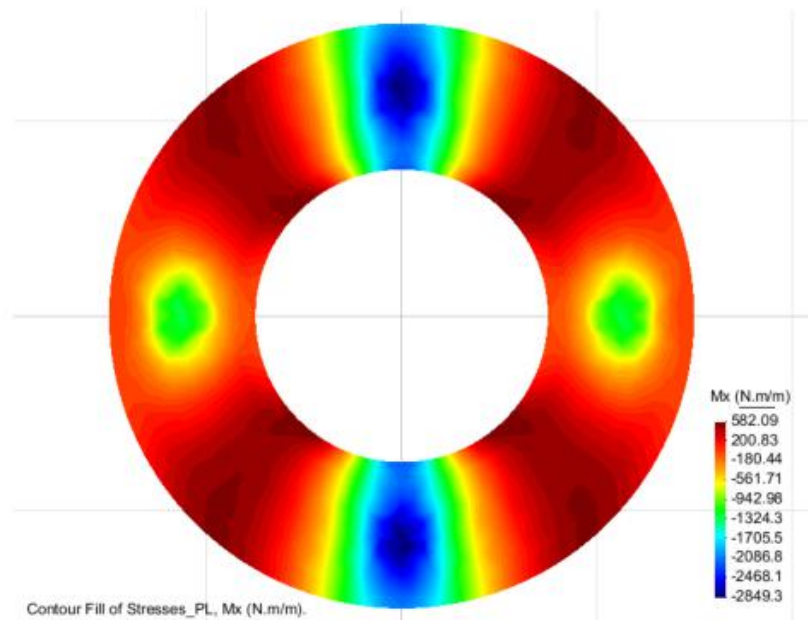

Figure 29. Moment Mx

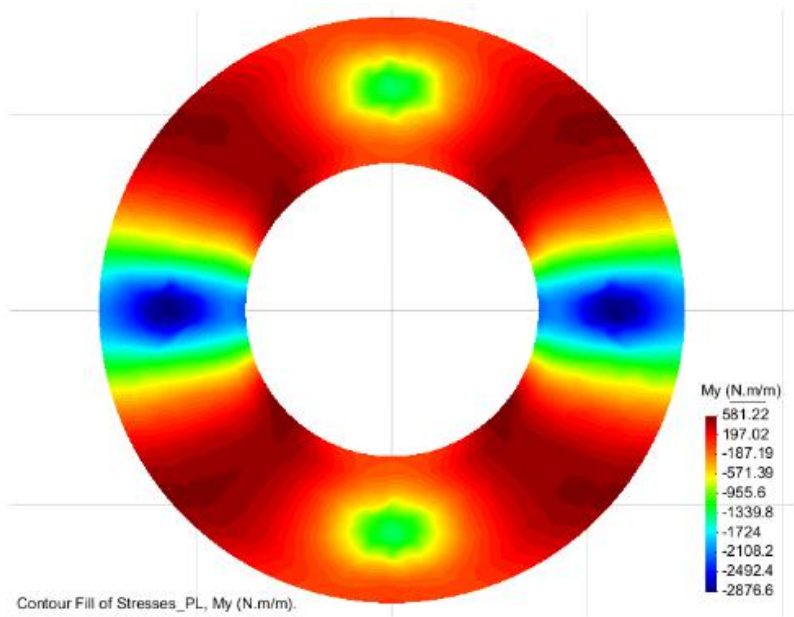

Figure 30. Moment My

The element is perfectly symmetrical and we observe that the stresses in x and y direction are same but in opposite direction.

Results for shear stresses are presented in Figure 31 and Figure 32.

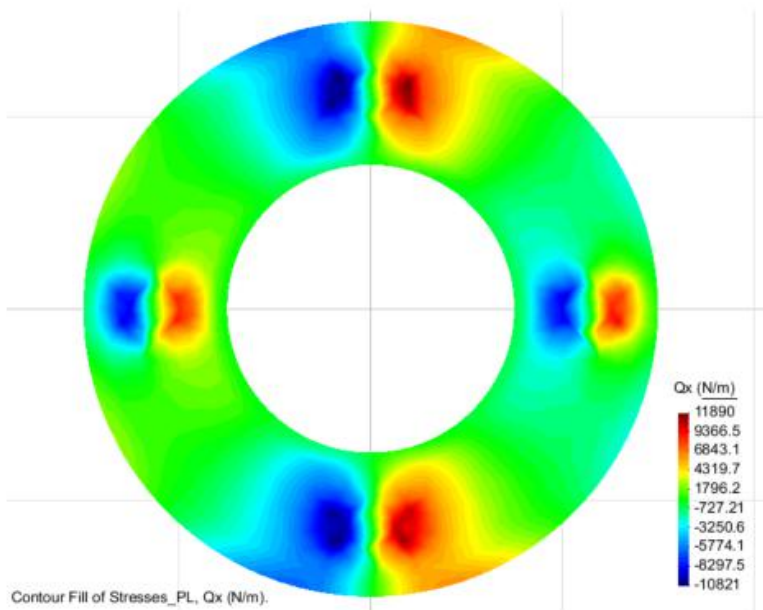

Figure 31. Stresses Qx

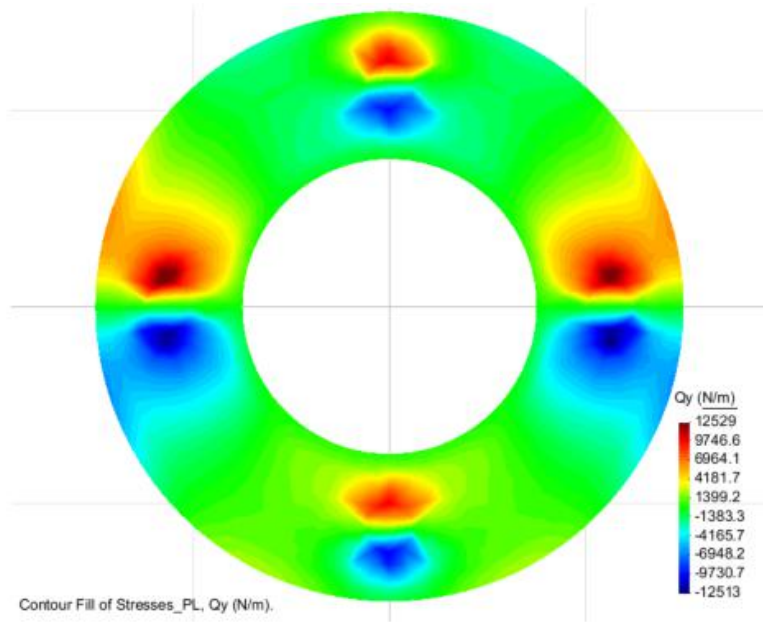

Figure 31. Stresses Q_y

We observe a rapid change from positive to negative in stresses.