



UNIVERSITAT POLITÈCNICA  
DE CATALUNYA  
BARCELONATECH



Erasmus  
Mundus

UNIVERSITAT POLITÈCNICA DE CATALUNYA, BARCELONA

MSC. COMPUTATIONAL MECHANICS ERASMUS MUNDUS

## GID ASSIGNMENT 3

---

# Computational Structural Mechanics & Dynamics

---

*Author:*

Nikhil Dave

Date: April 20, 2018

## Exercise 1: Clamped plate with a uniform load

Analyse the state of stress of the quadratic plate in the figure, whose four sides are clamped. The plate is submitted to a uniform load  $q$ . Use triangular plate elements DKT, triangular Reissner-Midlin elements with 6 nodes with reduced integration and quadrilateral elements CLLL for the analysis. Compare the obtained results for the deflection in the center of the plate with the analytical solution.

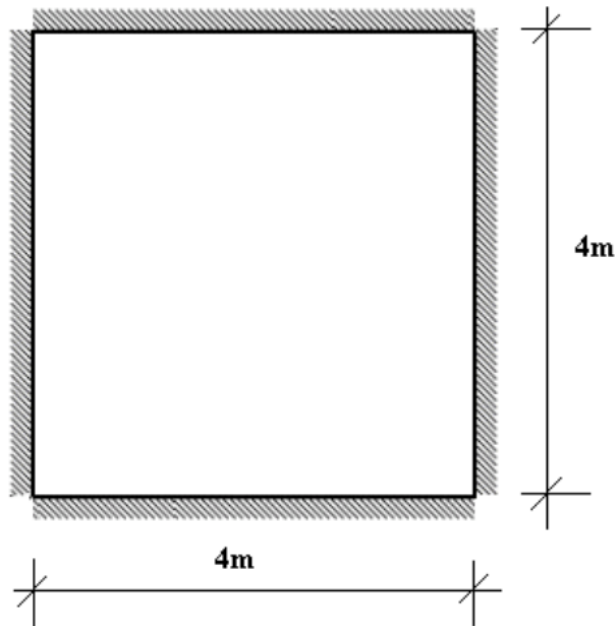

Figure 1: Clamped plate with a uniform load

### Solution:

#### 1.1. Purpose of the exercise

The objective of this exercise is to analyse the state of stress of the plate, clamped on all sides and submitted to uniform load. To understand the effect of the elements used, we will compare the results from triangular DKT elements, triangular RM elements and quadrilateral CLLL elements with the analytical solution.

#### 1.2. Analysis

##### 1.2.1 Pre-processing

###### (i) Geometry

The first step of pre-processing is to model the geometry as per the given dimensions in GiD as shown in Figure 2.

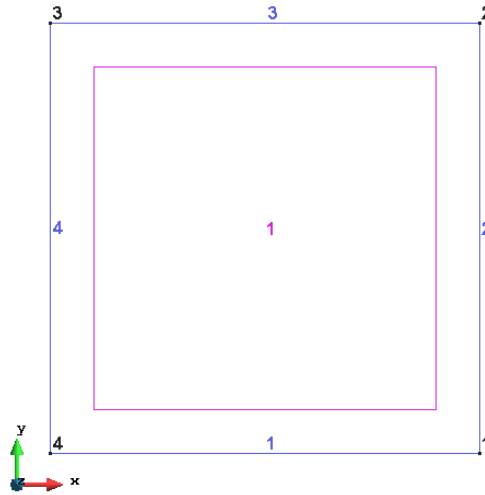

Figure 2: Defining the geometry

**(ii) Data**

Once the geometry is defined, we apply the given data to the model.

**Problem type**

For the given problem we use the Plates problem type from the Ramseries Educational module.

**Boundary Conditions**

Next, we define the boundary conditions as shown in Figure 3 and 4. Firstly, displacement constraint is applied to simulate clamped sides of the plate with zero displacement and rotations. The given uniform load  $q = 1.0e4N/m^2$  is then applied to the top surface of the plate.

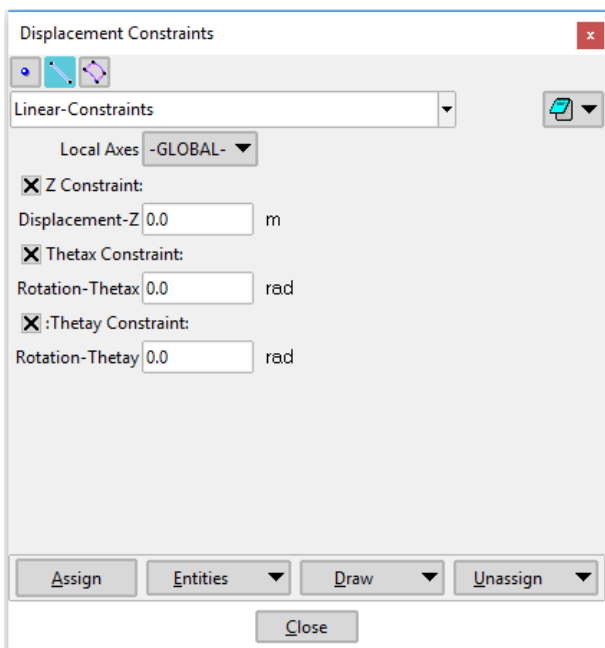

(a)

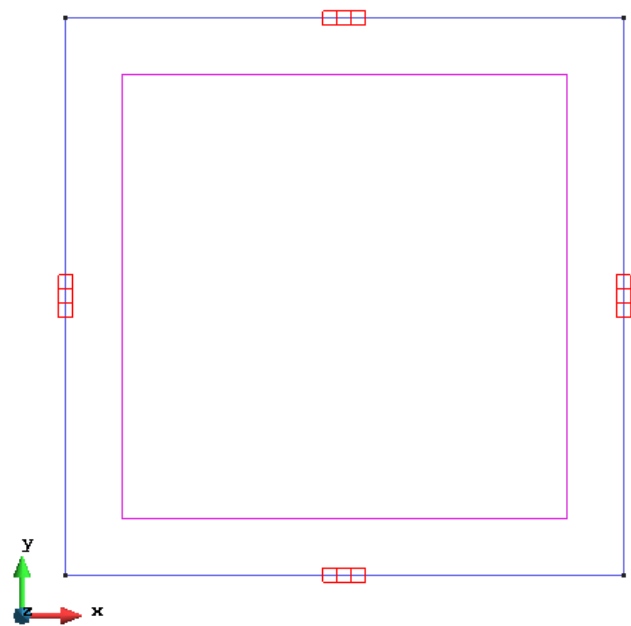

(b)

Figure 3: Boundary conditions - displacement constraint

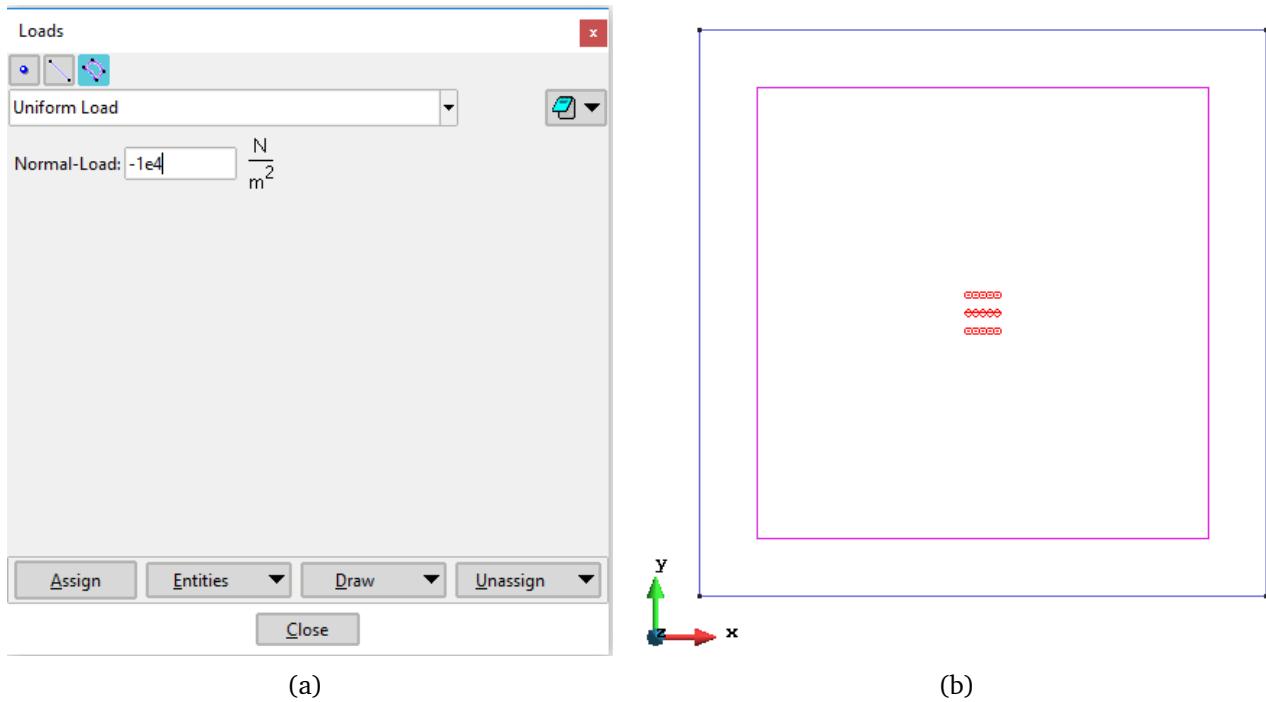

Figure 4: Boundary conditions - Uniform load

**Material**

The material properties of the structure are defined with the parameters of concrete as shown in Figure 5.

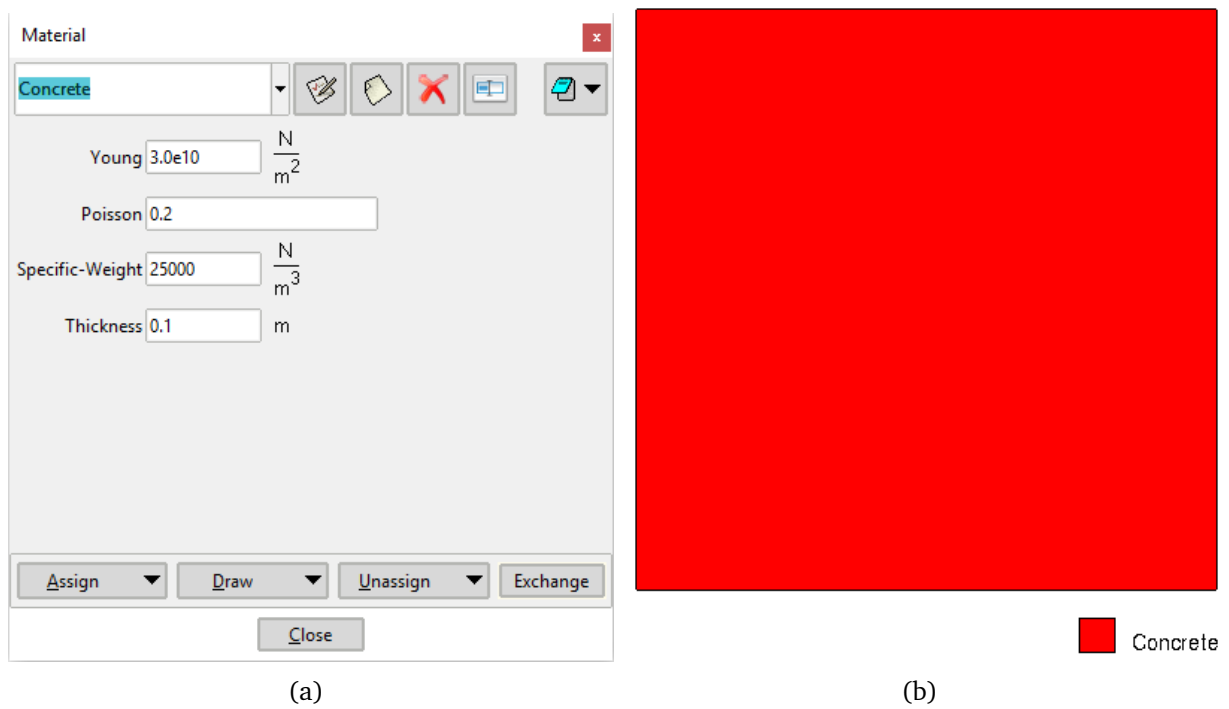
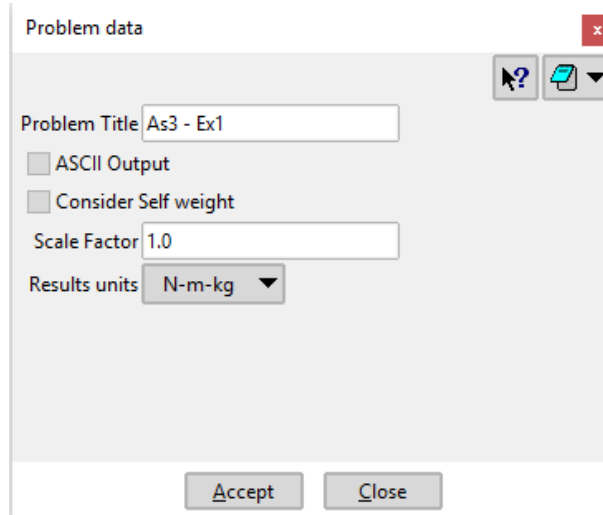

Figure 5: Material properties defined

**Problem Data**

The definition of problem data is an important step for the analysis where the options like title, type of problem and the result units are to be selected. It is important to note here that the self weight is not considered in this problem. Figure 6 shows the data used for this problem.



**Figure 6:** Problem data defined

**Mesh**

In this problem, a structured mesh is used with linear triangular (DKT), quadratic triangular (RM) and linear quadrilateral (CLLL) elements with different element sizes to check the convergence of the solution. Figures 7 - 9 shows the coarse mesh (size = 1) for all three elements.

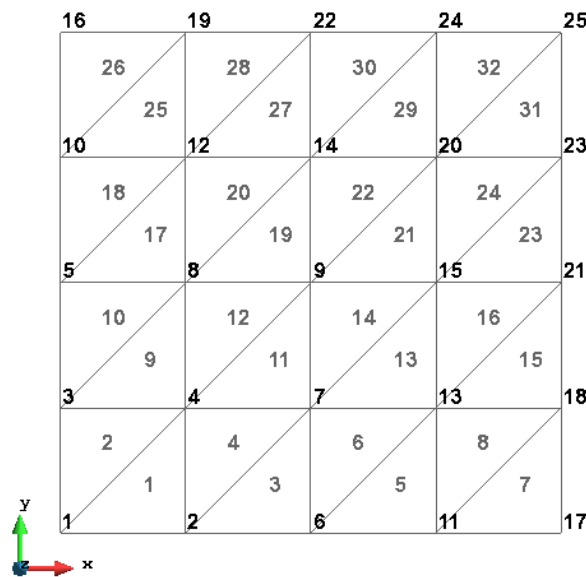

**Figure 7:** Linear triangular (DKT) elements - Coarse mesh

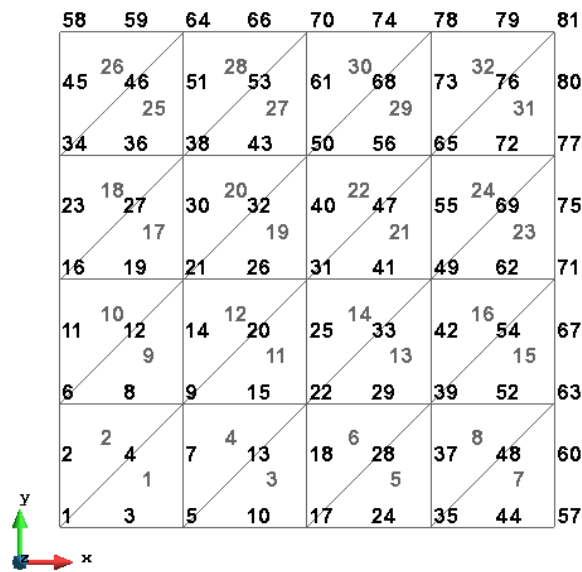

Figure 8: Quadratic triangular (RM) elements - Coarse mesh

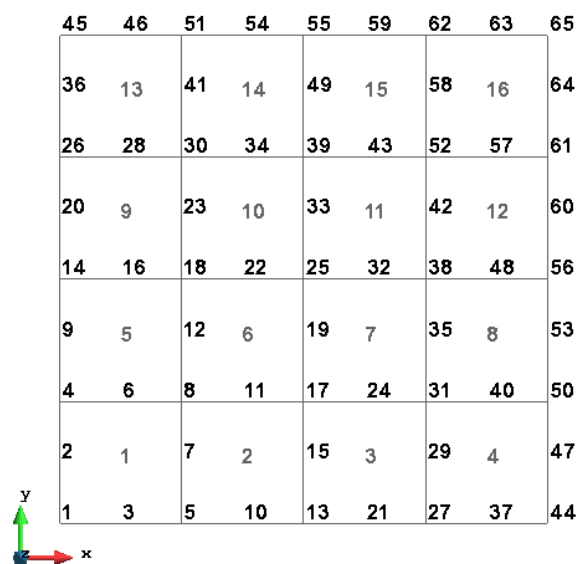
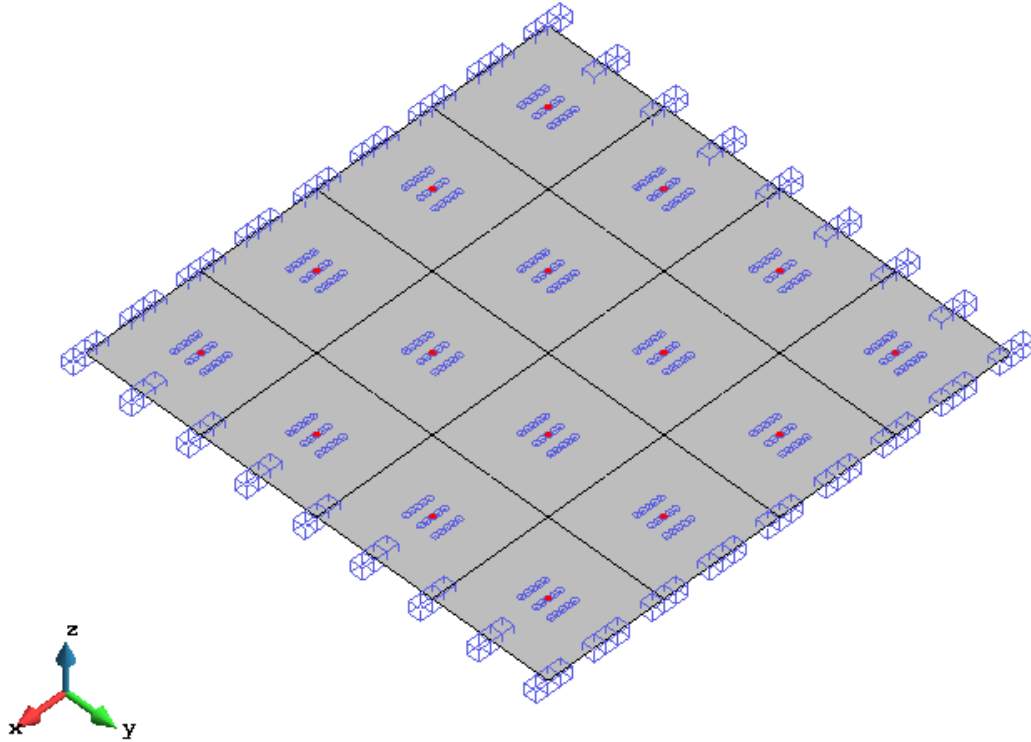

Figure 9: Linear quadrilateral (CLLL) elements - Coarse mesh

### 1.2.2 Processing

In this section, we calculate the solution of the problem for the given data, boundary conditions and generated mesh as shown in Figure 10.



**Figure 10:** Problem to be solved

### 1.2.3 Post-processing

First, we need to find the analytical solution of the problem, in order to compare with the results obtained from different elements. For a plate clamped on four sides, the maximum displacement is given as,

$$\delta = \frac{\alpha q L^4}{EI}$$

where,

$$I = \frac{t^3}{12(1 - \nu^2)} \quad \text{and} \quad \alpha = 0.0012567$$

Using these relations, we obtain,

$$\delta = 0.0012354 \text{ m}$$

The analysis is performed for different mesh sizes, the results shown below are obtained for the finest mesh size considered of 0.125. Firstly, the results for DKT elements are shown followed by RM and CLLL elements.

**DKT elements**

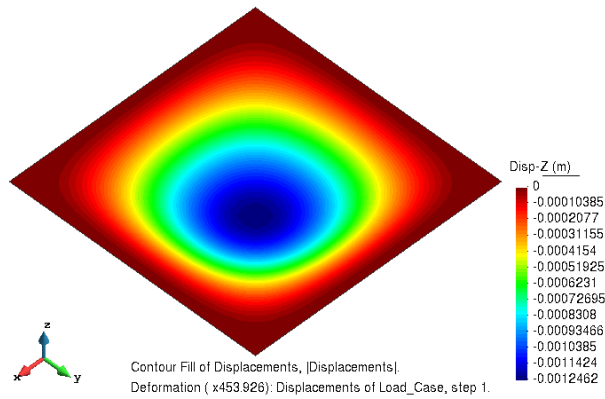

**Figure 11:** Results: displacements in the  $z$ -direction plotted on deformed configuration

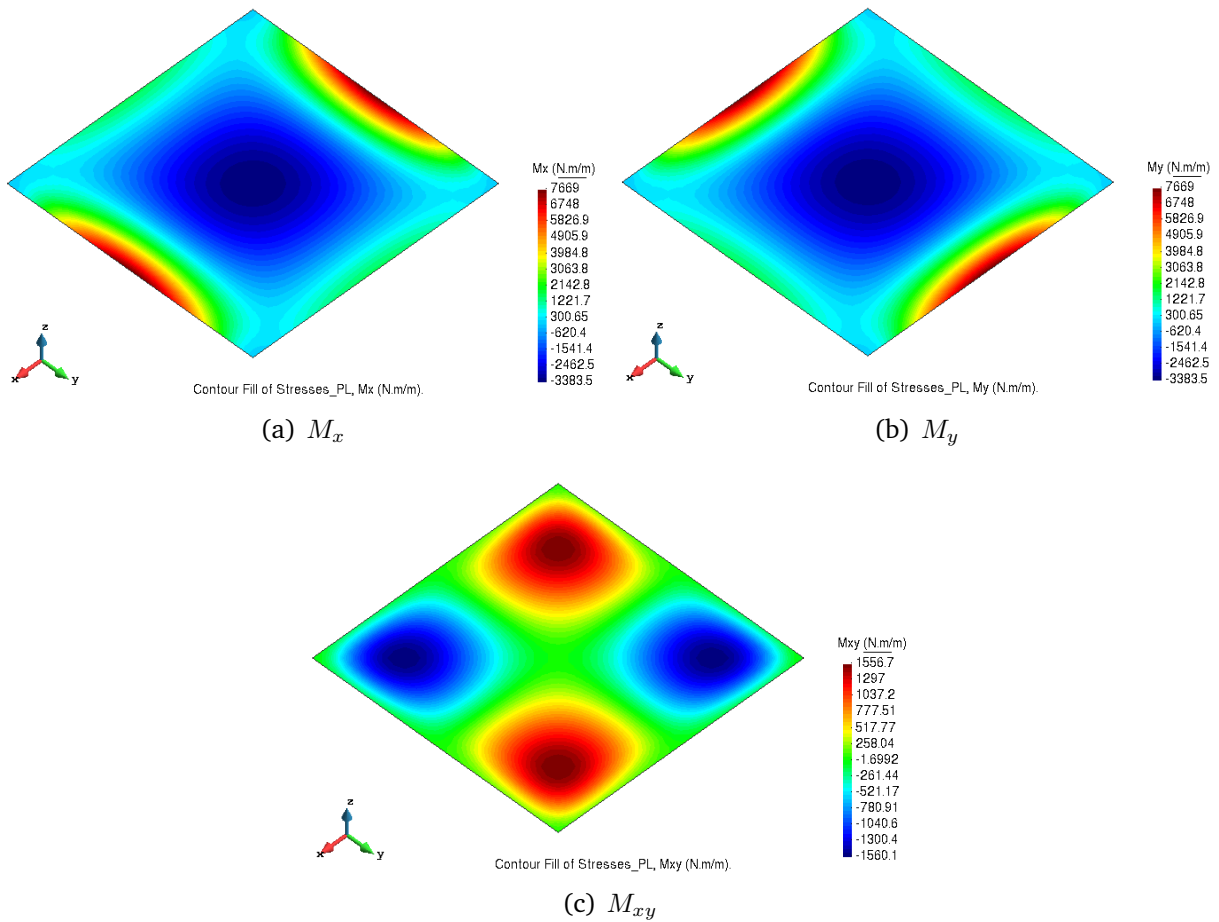

**Figure 12:** Results: Bending stress plots



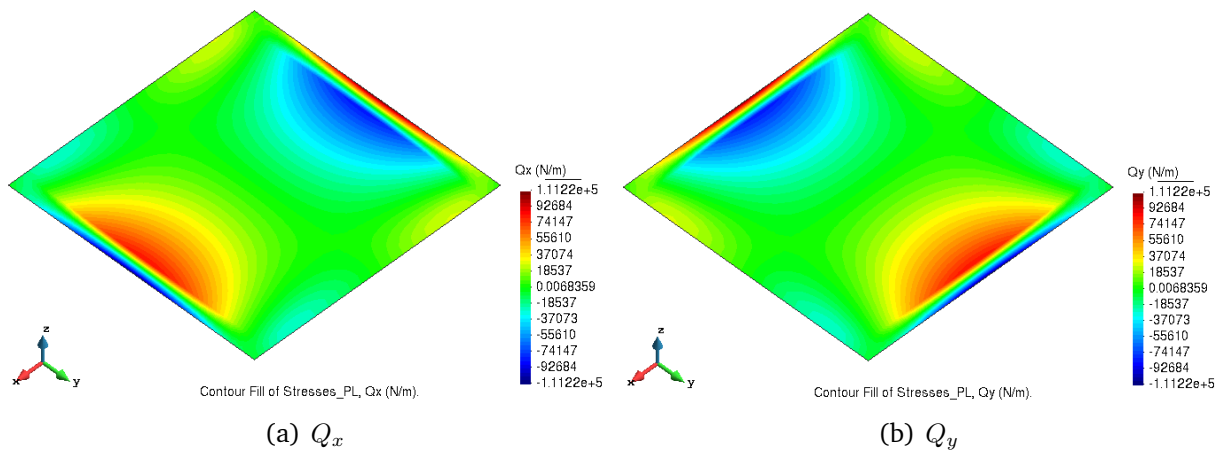

Figure 13: Results: Shear stress plots

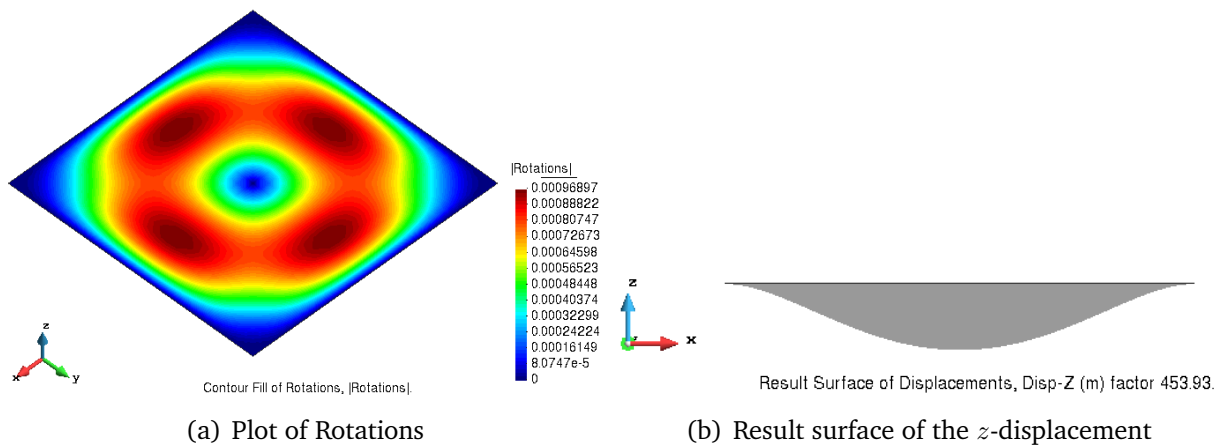
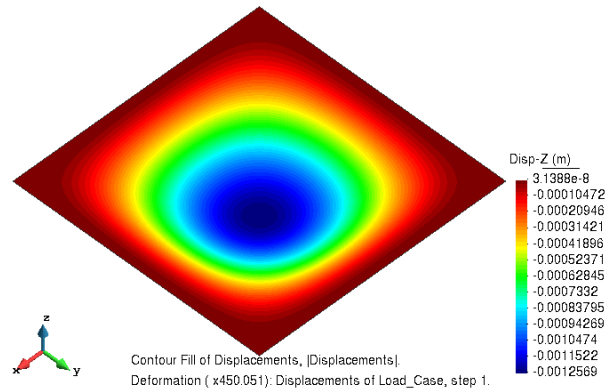

Figure 14: Result plots

Mesh size	Number of nodes	Number of elements	Displacement at centre node (m)	Relative % error
1	25	32	-0.0013591	10.0129512708
0.5	81	128	-0.0012796	3.5777885705
0.25	289	512	-0.0012532	1.44082888133
0.125	1089	2048	-0.0012462	0.87421078193

Table 1: Comparison table for results obtained with different mesh sizes of DKT elements

**RM elements**



**Figure 15:** Results: displacements in the  $z$ -direction plotted on deformed configuration

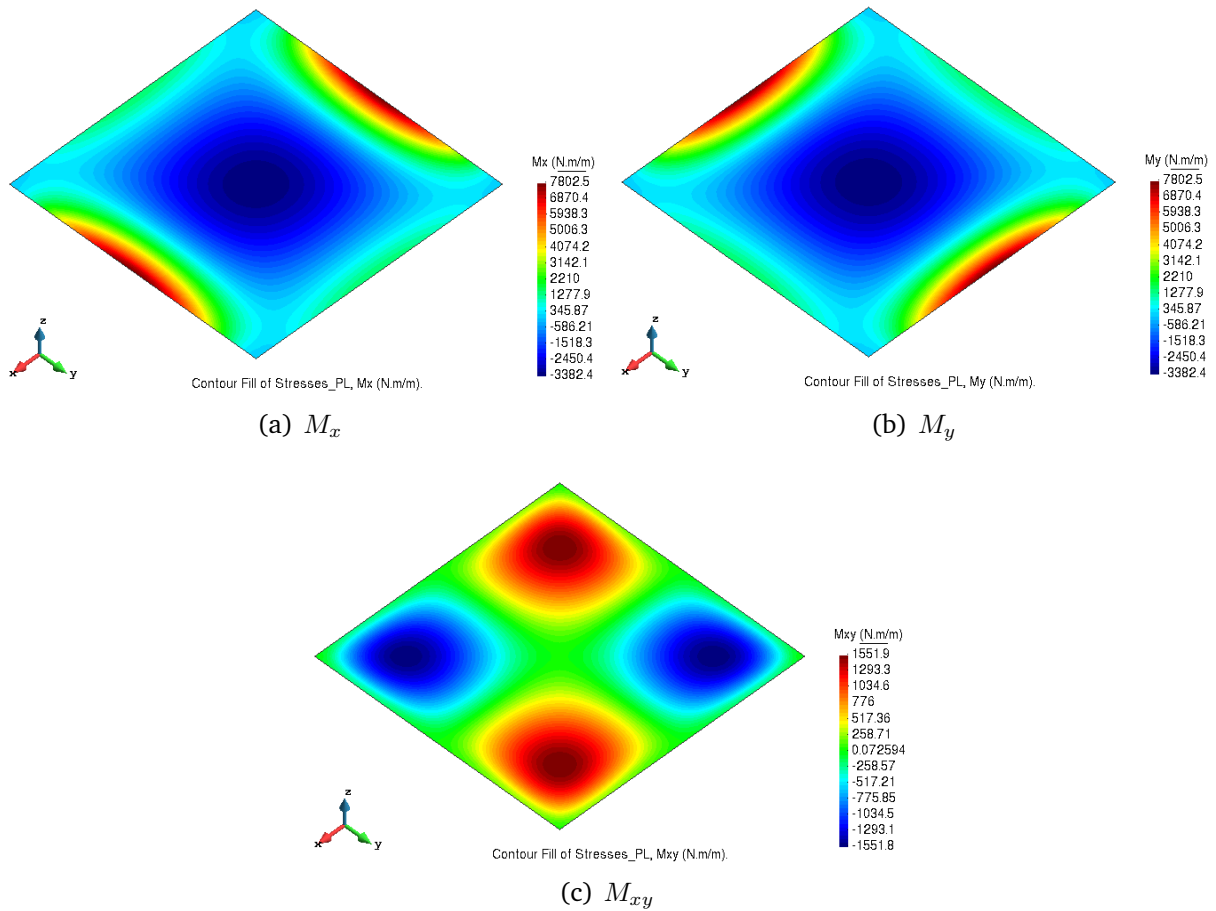

**Figure 16:** Results: Bending stress plots

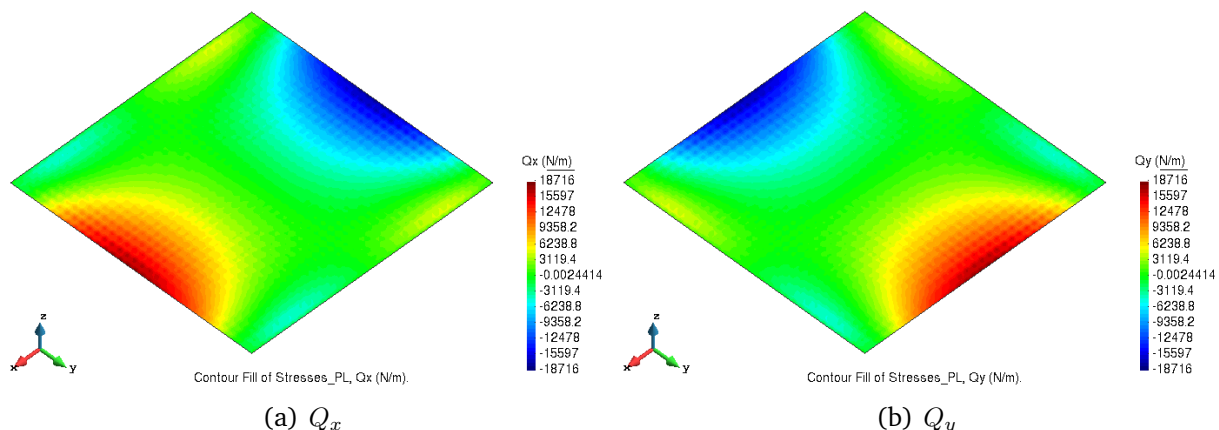

Figure 17: Results: Shear stress plots

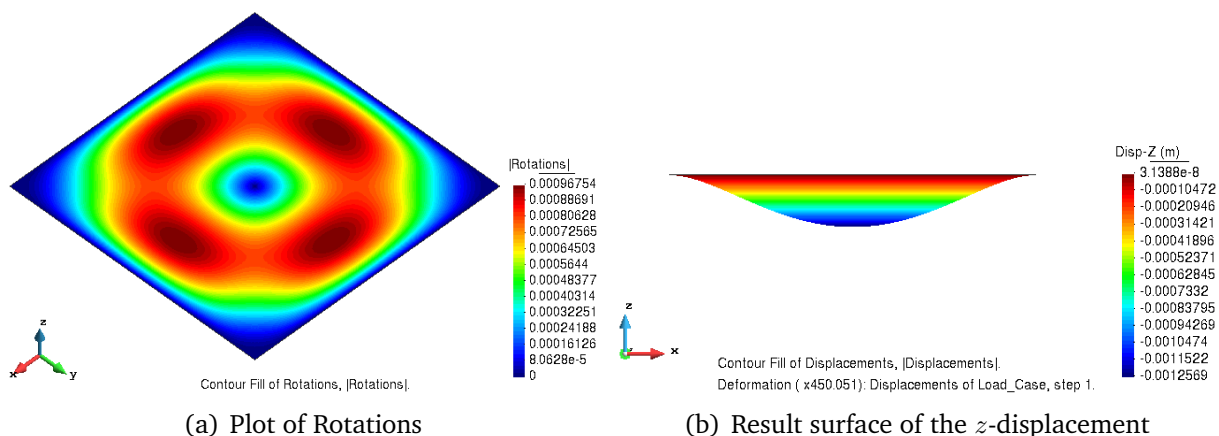
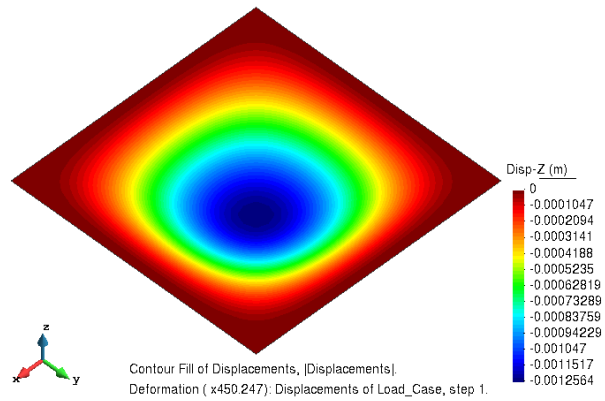

Figure 18: Result plots

Mesh size	Number of nodes	Number of elements	Displacement at centre node (m)	Relative % error
1	81	32	-0.00074563	39.6446495062
0.5	289	128	-0.0011846	4.1120284928
0.25	1089	512	-0.0012511	1.27084345151
0.125	4225	2048	-0.0012569	1.74032701959

Table 2: Comparison table for results obtained with different mesh sizes of RM elements

**CLLL elements**



**Figure 19:** Results: displacements in the  $z$ -direction plotted on deformed configuration

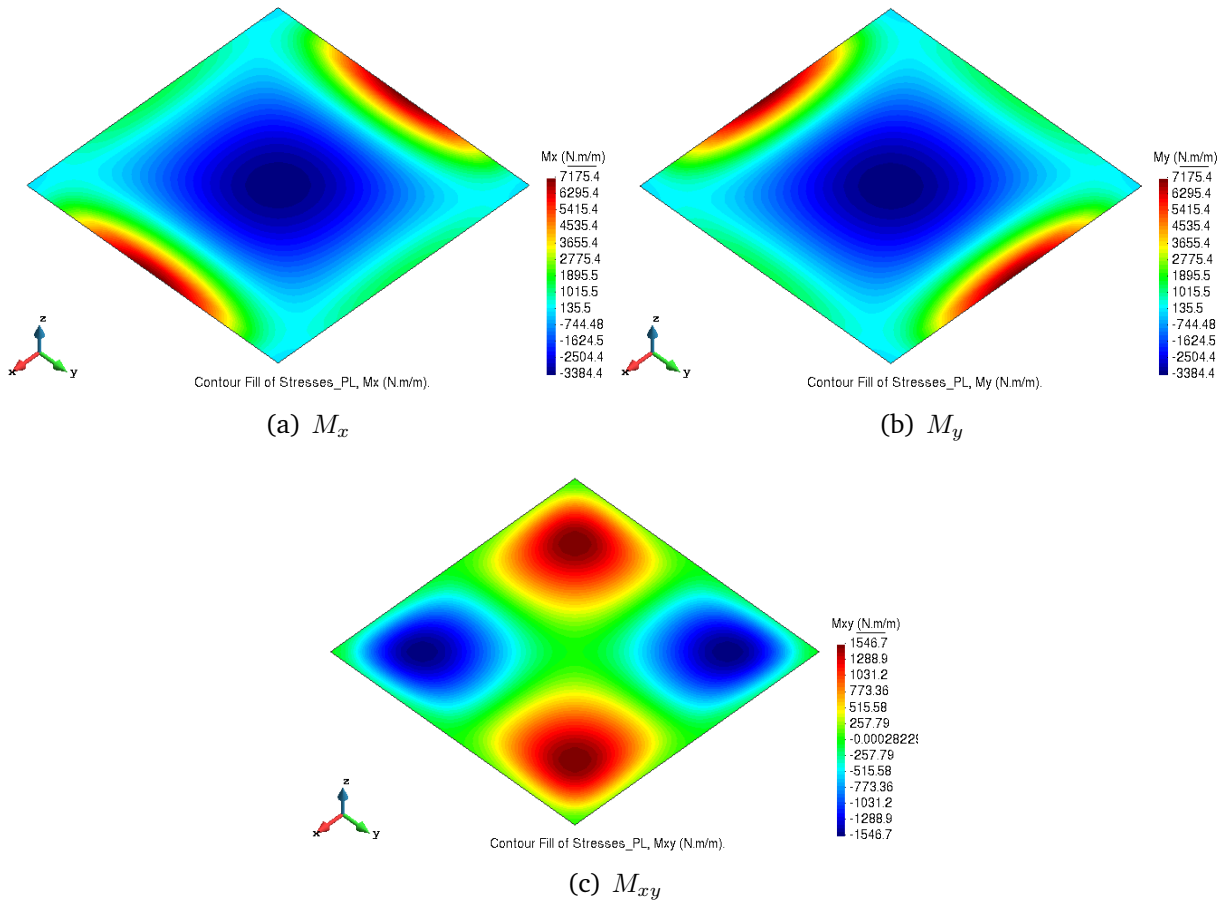

**Figure 20:** Results: Bending stress plots

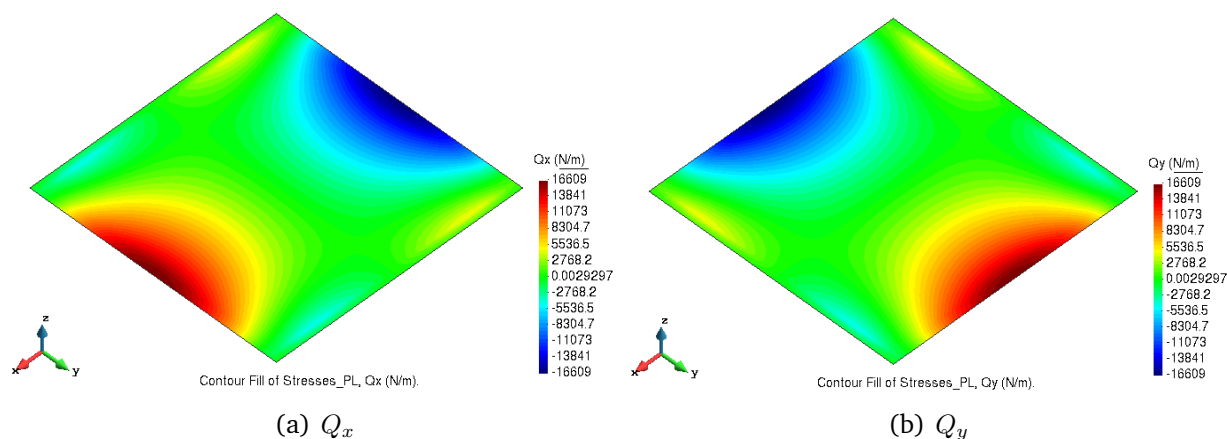

Figure 21: Results: Shear stress plots

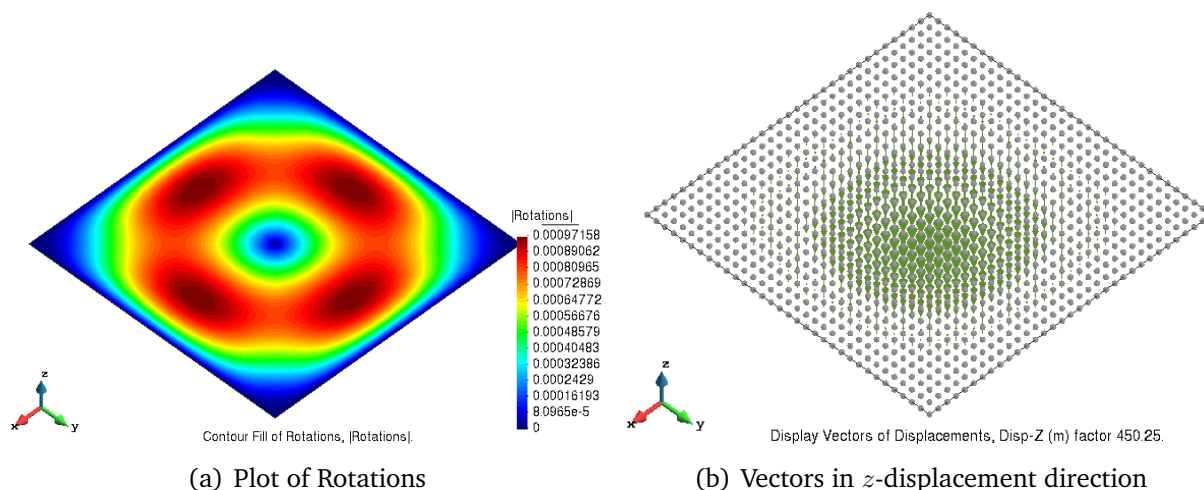

Figure 22: Results obtained

Mesh size	Number of nodes	Number of elements	Displacement at centre node (m)	Relative % error
1	25	16	-0.0011994	2.91403593978
0.5	81	64	-0.0012419	0.52614537801
0.25	289	256	-0.0012534	1.45701796989
0.125	1089	1024	-0.0012564	1.6998542982

Table 3: Comparison table for results obtained with different mesh sizes of CLLL elements

### 1.3. Comparison of the results

The results obtained for displacement, stresses, rotations etc. are shown for all element types. It is seen that the model is working in accordance to the theory of plates clamped on all sides and subjected to uniform load. We notice variation in the results while using different meshes. To study the accuracy of these meshes, we compared the obtained results with the derived analytical solution for clamped plates. It can be clearly observed that the DKT elements performs the best among the other mesh types. The reason for this being less number of nodes than RM element in the comparison of triangular meshes, and more number of elements than the quadrilateral element.

## Exercise 2: Thin plate with internal hole

The figure shows a steel plate supported on four columns. Analyse the structural behaviour of the plate using the theory of thin plates. Use triangular elements DKT.

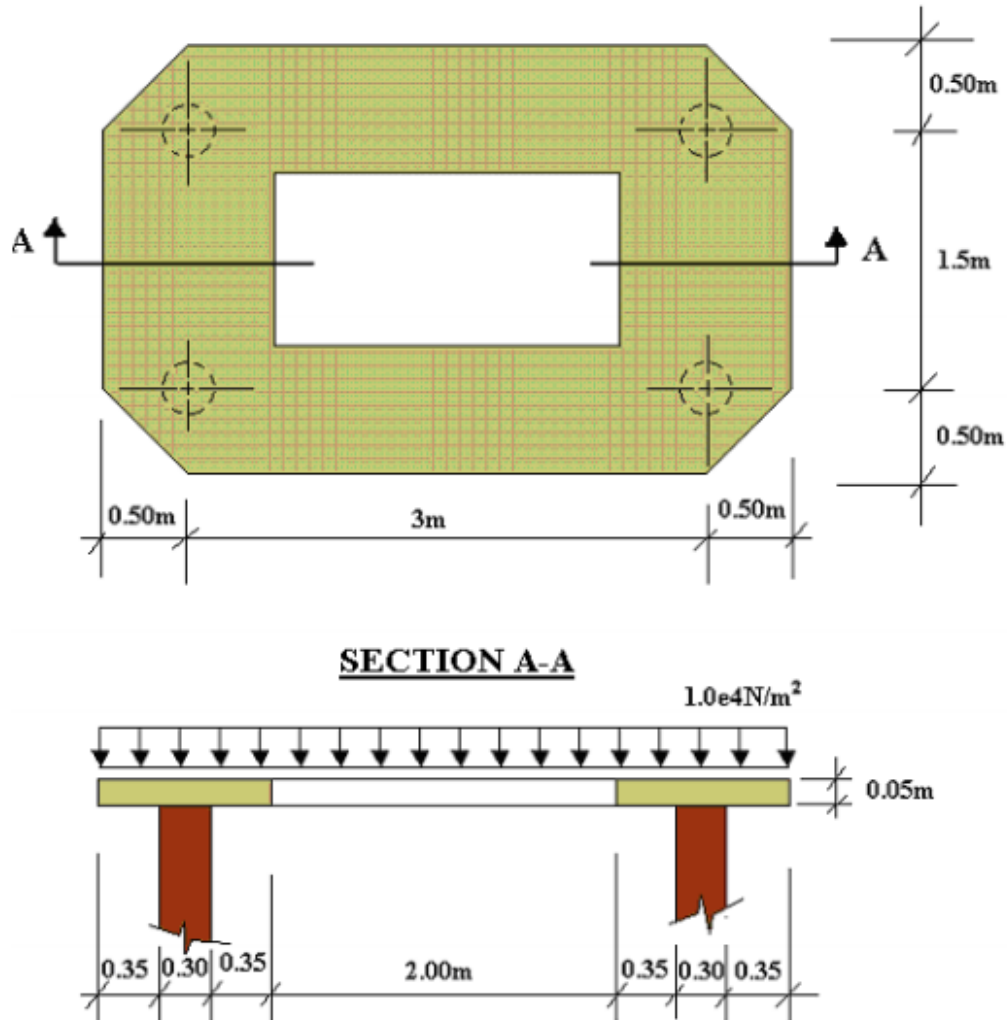

Figure 23: Thin plate with internal hole

### Solution:

#### 2.1. Purpose of the exercise

The objective of this exercise is to analyse the given steel plate with the thin plate theory.

#### 2.2. Analysis

##### 2.2.1 Pre-processing

###### (i) Geometry

The first step of pre-processing is to model the geometry of the plate as per the given dimensions in GiD as shown in Figure 24.

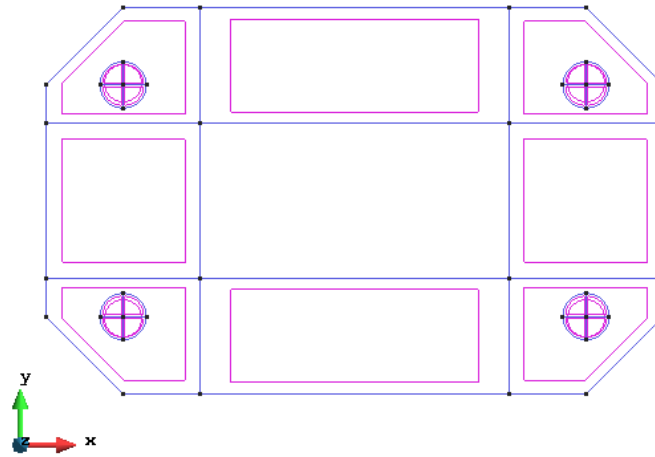

Figure 24: Defining the geometry

**(ii) Data**

Once the geometry is defined, we apply the given data to the model.

**Problem type**

For this analysis, we select the Plates problem type from the Ramseries Educational module.

**Boundary Conditions**

Next, we define the boundary conditions for the problem as shown in Figure 25. Firstly, we apply an elastic constraint on the contact area between the support and plate to restrict the displacement with a high value. Also, a uniform load is applied on the plate surface.

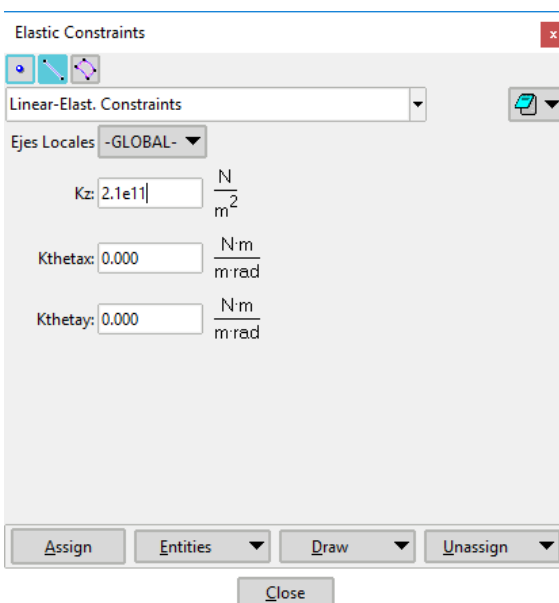

(a) Elastic constraint

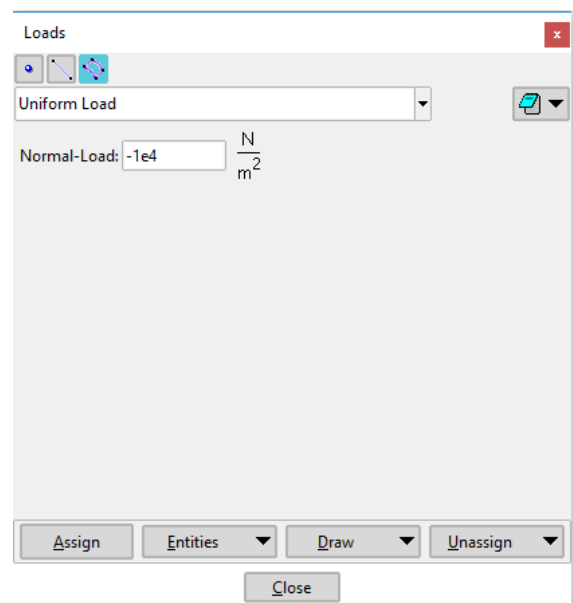

(b) Uniform load

Figure 25: Boundary conditions



## Material

Material properties of the structure are defined with given parameters shown in Figure 26.

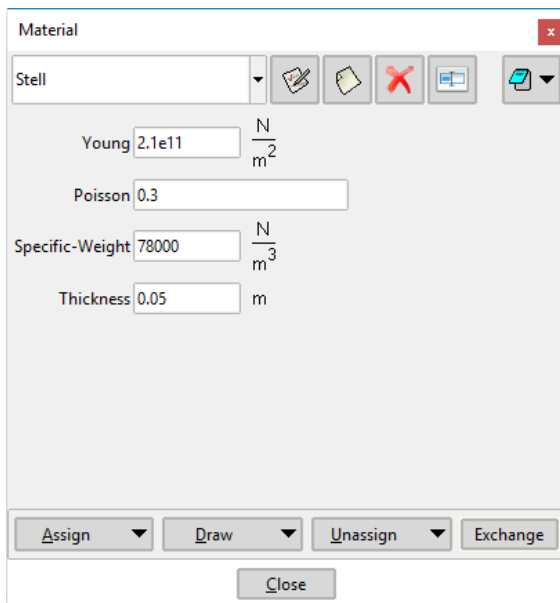

(a) Material properties

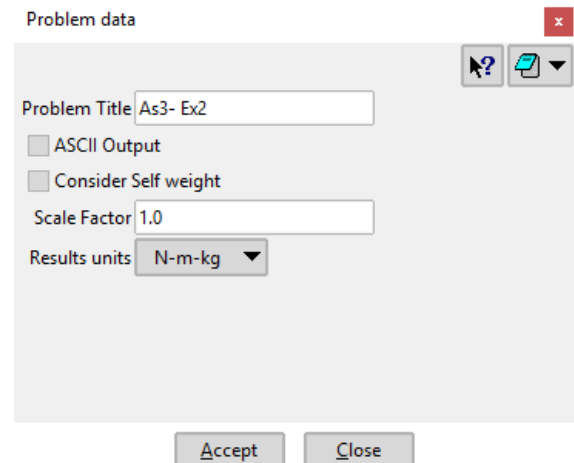

(b) Problem data

Figure 26: Assigned data

## Problem Data

Figure 26 also show the necessary problem data used for this problem.

## Mesh

Here we generate a structured mesh of linear triangular (DKT) elements as shown in Figure 27.

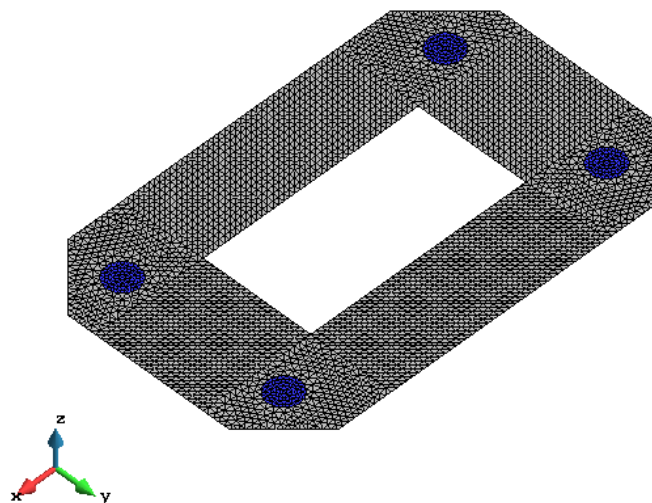

Figure 27: Generated mesh

### 2.2.2 Processing

In this stage, we run the problem with the given data and using the mesh generated.

### 2.2.3 Post-processing

The results obtained for the simulation is shown in this section.

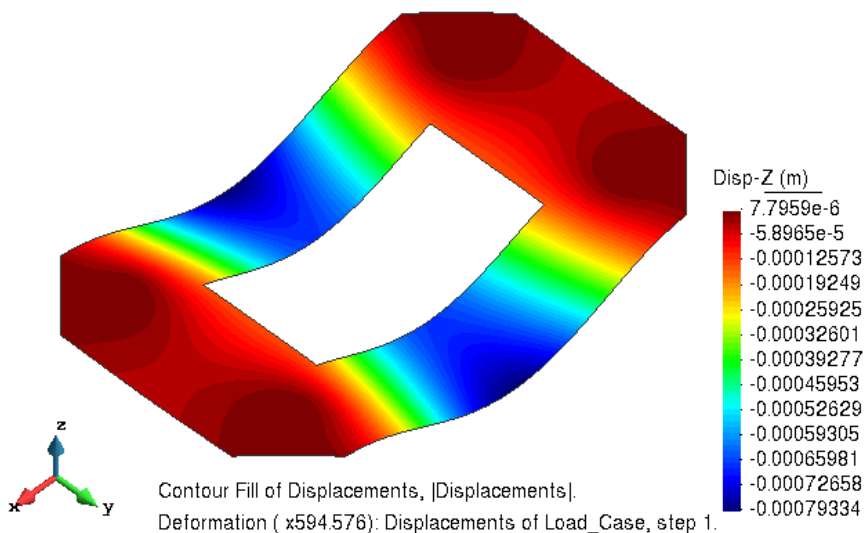

Figure 28: Results: displacements in the z-direction plotted on deformed configuration

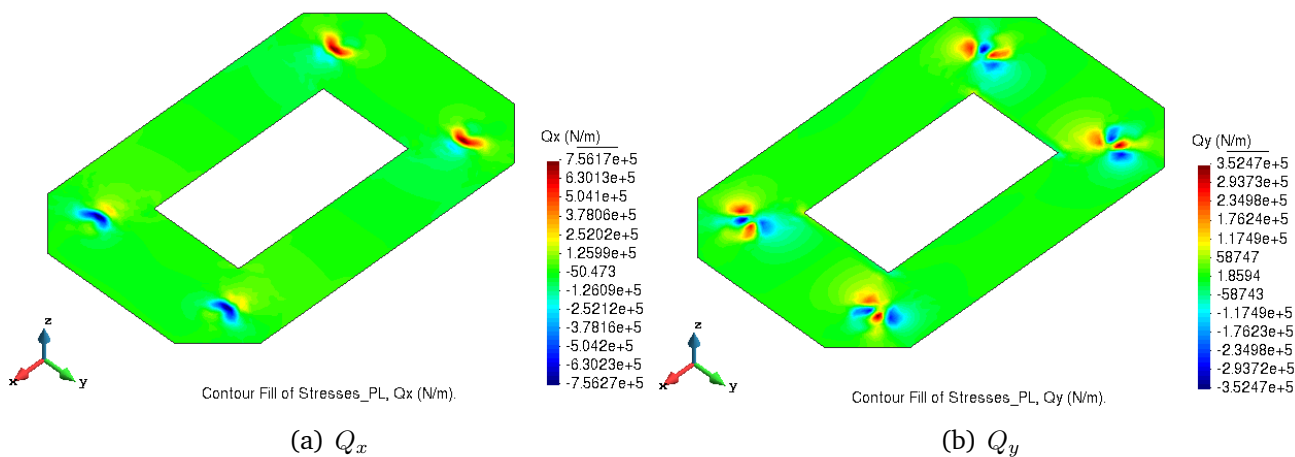

Figure 29: Results: Shear stress plots

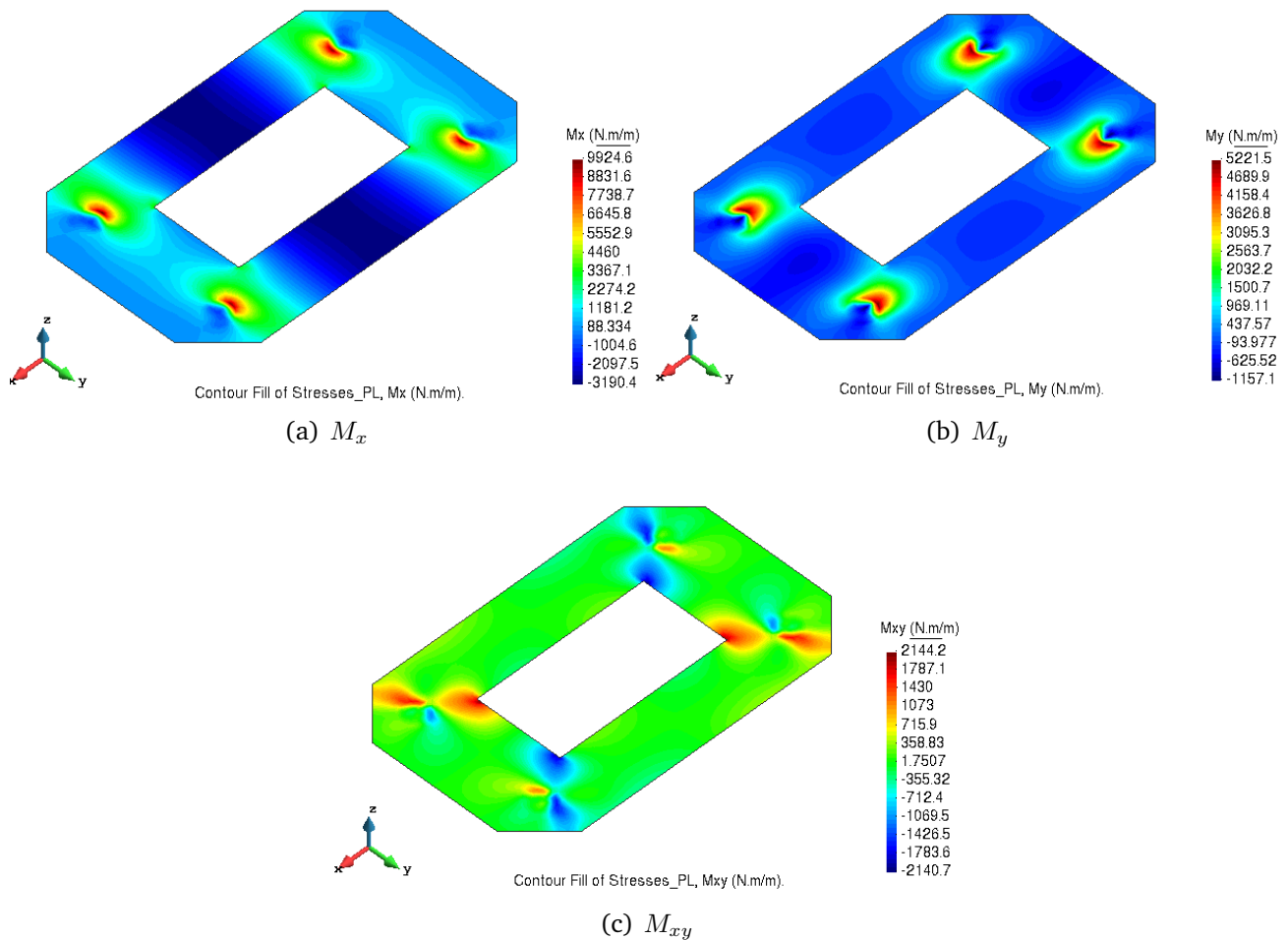

Figure 30: Results: Bending stress plots



Figure 31: Results: Result surface in z-displacement direction

We can observe from the results obtained that the displacement at the support columns is not present. The variation in displacement is seen due to the application of uniform load on the plate surface which generates a gradient in the displacement with maximum value at the centre of the structure and consequent reduction as we move towards the ends. The deformed configuration also confirms the correctness of our model set-up. The shear stresses are concentrated around the supports with equal and opposite values as expected. The bending stresses are also concentrated around the support columns and symmetric in nature which validates our implementation.

### Exercise 3: Thick circular plate with internal hole

The figure shows a reinforced concrete plate supported on four columns, submitted to its dead weight and a uniform load. Analyse the structural behaviour using the theory of thick plates of Reissner-Mindlin. Use triangular elements of Reissner-Mindlin with six nodes and reduced integration.

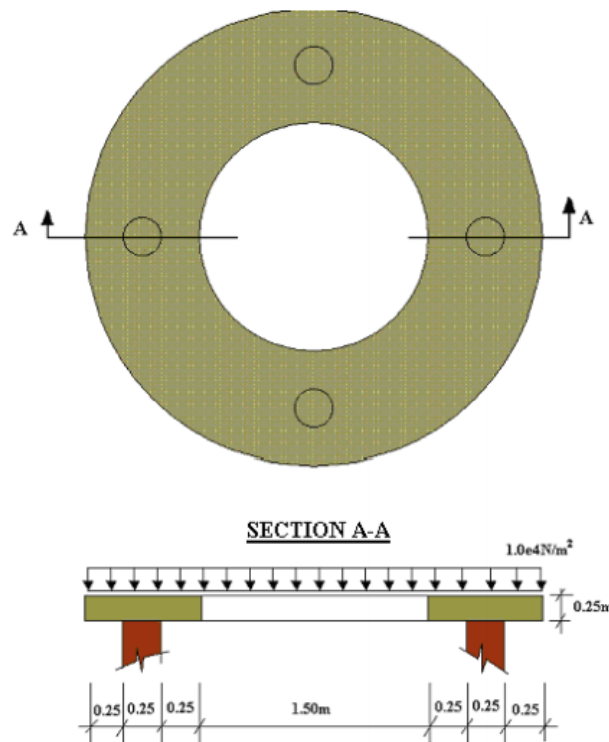

Figure 32: Thick circular plate with internal hole

### Solution:

#### 3.1. Purpose of the exercise

The objective of this exercise is to analyse the behaviour of the concrete plate with thick plate theory.

#### 3.2. Analysis

##### 3.2.1 Pre-processing

###### (i) Geometry

The first step of pre-processing is to model the geometry of the plate as per the given dimensions using GiD as shown in Figure 33.

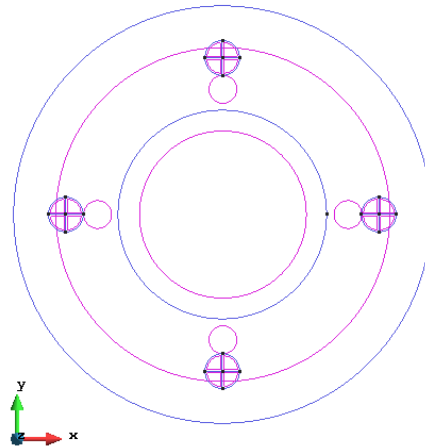

Figure 33: Defining the geometry

### (ii) Data

Once the geometry is defined, we apply the given data to the model.

### Problem type

For simulating the plate theory, we select the Plates problem type from the Ramseries Educational module.

### Boundary Conditions

Next, we define the boundary conditions for the problem as shown in Figure 34. Firstly, we apply an elastic constraint on the contact area between the support and plate to restrict the displacement with a high value. Also, a uniform load is applied on the plate surface.

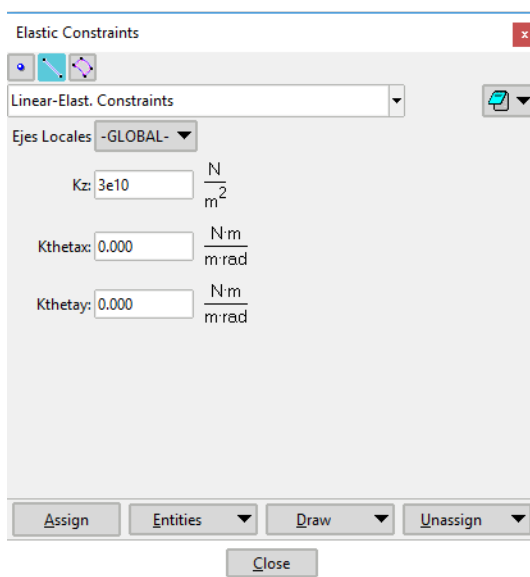

(a) Elastic constraint

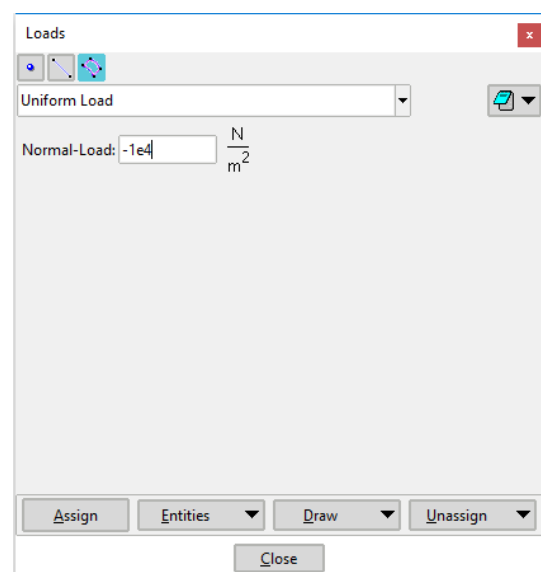

(b) Uniform load

Figure 34: Boundary conditions

### Material

The material properties of the structure is defined with the given parameters shown in Figure 35.

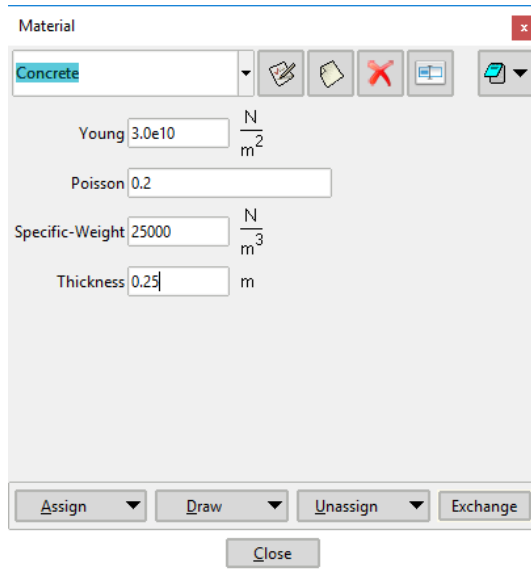

(a)

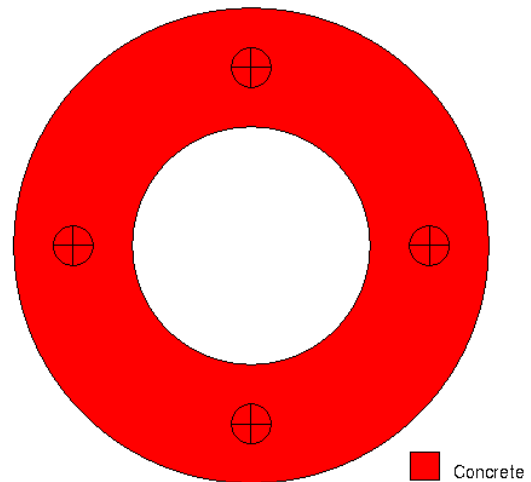

(b)

Figure 35: Material properties

### Problem Data

Figure 36 shows the necessary problem data used for this problem. It is important to note that we are considering self-weight in this analysis.

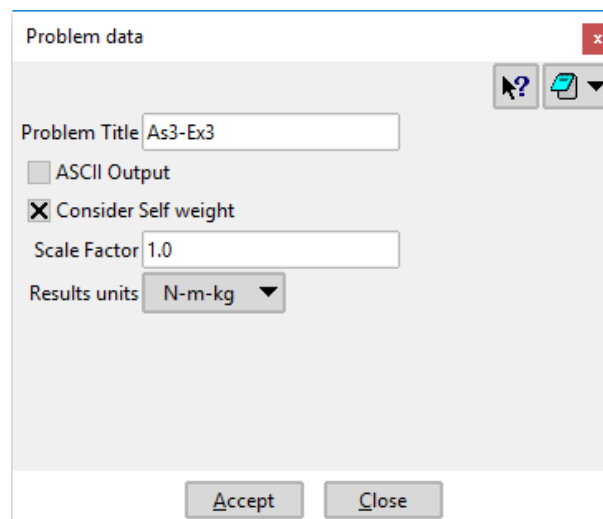
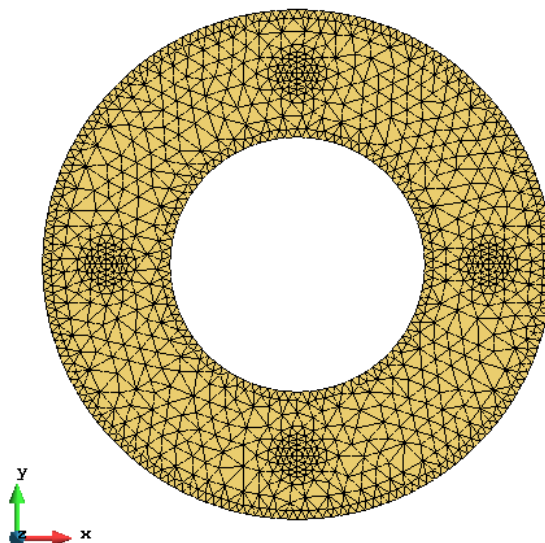

Figure 36: Problem data

**Mesh**

We consider a structured mesh of quadratic triangular (RM) elements as shown in Figure 37.



**Figure 37:** Generated mesh

**3.2.2 Processing**

After all the data is defined and the mesh is generated, the simulation is run.

**3.2.3 Post-processing**

The results obtained for the simulation is shown in this section.

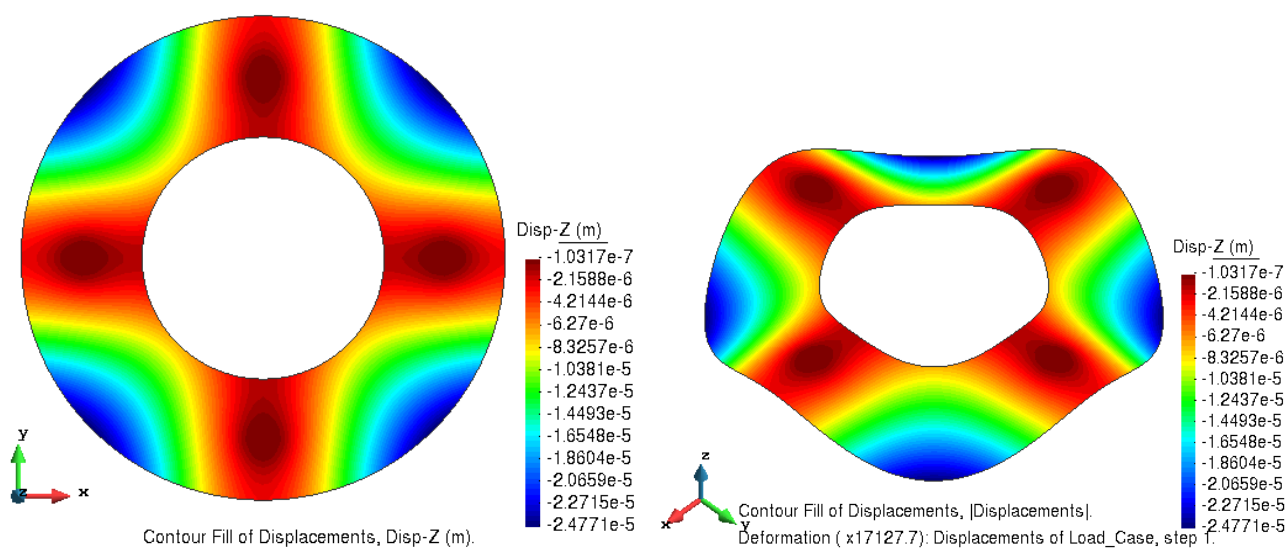

(a) Plotted on original configuration

(b) Plotted on deformed configuration

**Figure 38:** Results: displacements in the *z*-direction

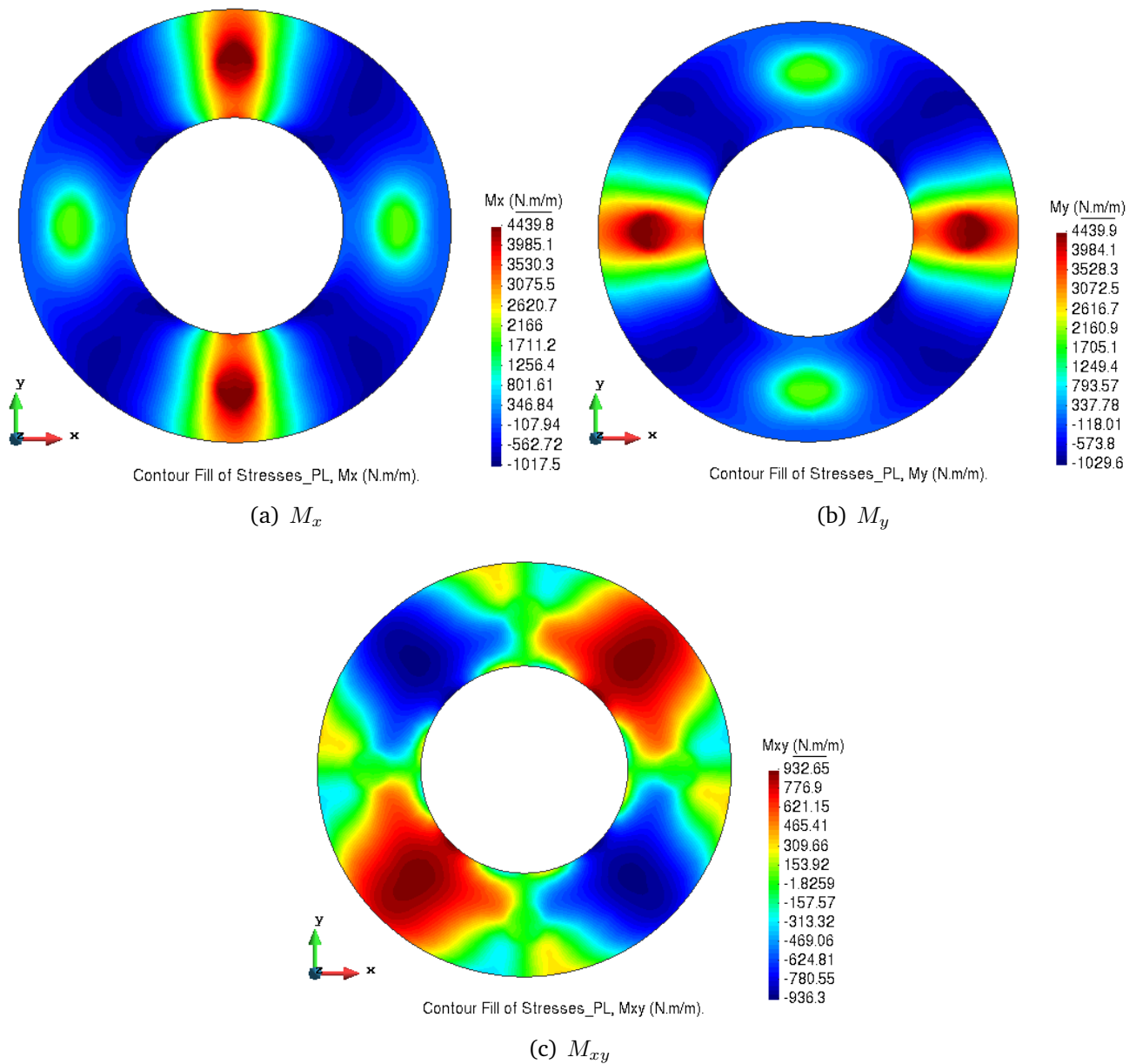

**Figure 39:** Results: Bending stress plots

We observe that the displacement is minimum at the supporting columns and maximum at the outer edge as expected from this problem. The bending stresses are concentrated near the supporting columns with symmetric nature.



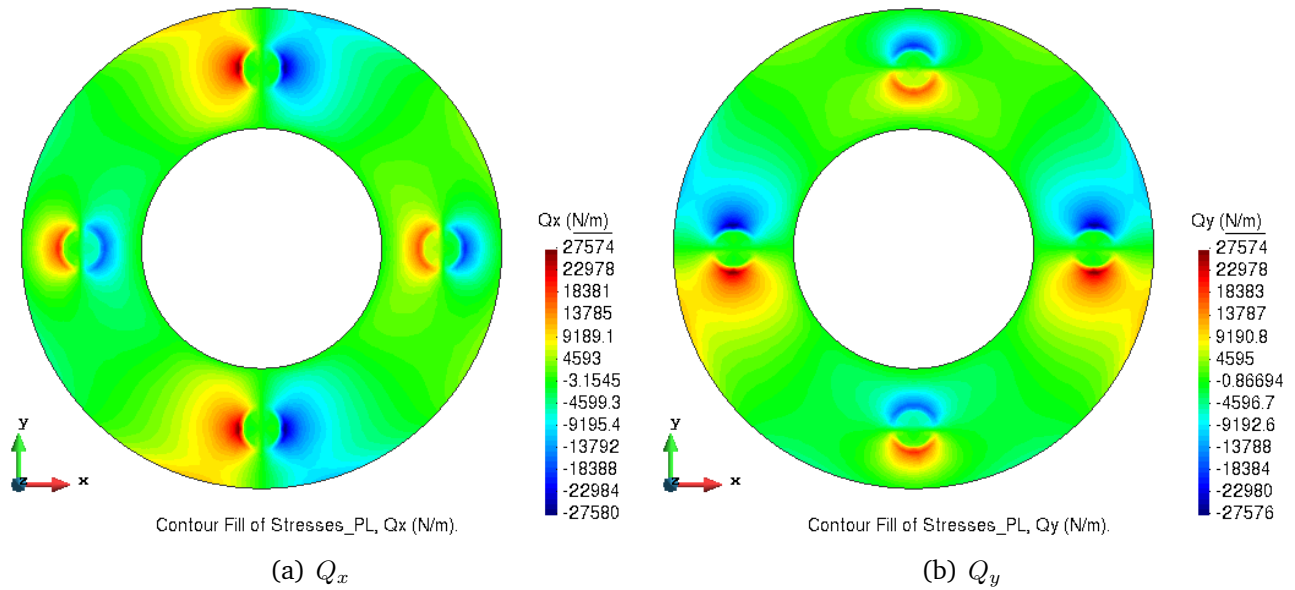

Figure 40: Results: Shear stress plots

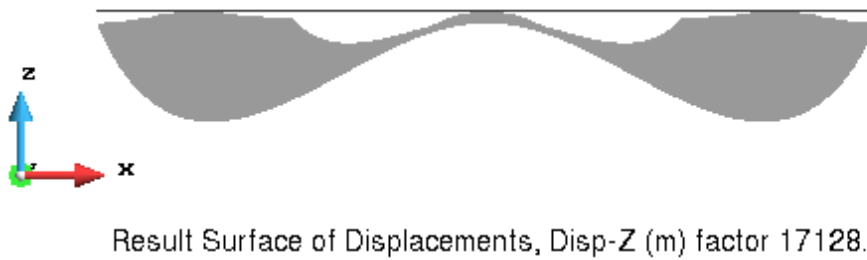

Figure 41: Results: Result surface in z-displacement direction

The symmetric behaviour of shear stresses around the supporting columns are compressive and tensile in nature which could be a potential reason for future failure. In this case, the displacements are very small in magnitude since the plate is thicker compared to the thin plate in exercise 2.